

SCHEMA TECHNIQUE – UE JET-CO2 QUATTRO STD

JET DE GAZ
CRYOGENIQUE CO2

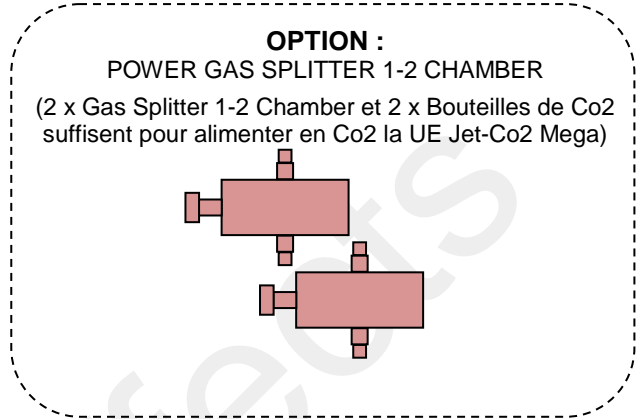
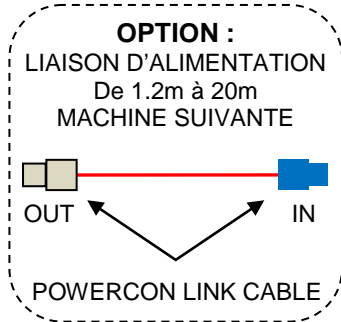
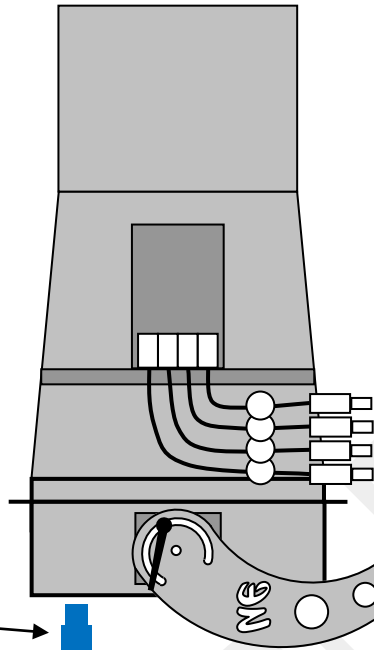
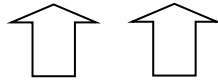

4 x
GAS HP-PIPE

4 x
Bouteilles de CO2
avec tube plongeur

(Bouteille non inclus ;
Demandez notre contrat
de Gaz Partenaire)

POWERCON SUPPLY CABLE

OPTION INTERFACE SAFETY PACK

1 x UE INTERFACE
SECURITY PACK

Voyant vert Voyant Rouge

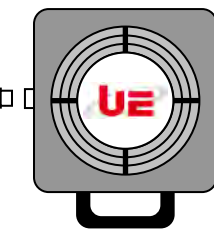

1 x UE LEVEL
DETECTOR-CO2

1 x UE
DETECTOR-CO2
CABLE

4 x
UE
CONNECTION
SYSTEM CO2

OU
4 x
CONNECTION ECO

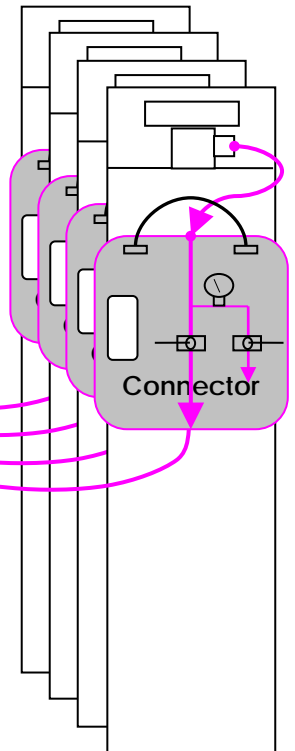
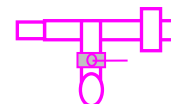

Alimentation
Electrique
220V – 50Hz

TECHNICAL DIAGRAM – UE JET-CO2 QUATTRO STD

