

USER MANUAL

uFlamer X1800

V1.1

2022.09

SHOWVEN[®]



SHOWVEN Technologies Co., Ltd

Thanks for choosing SHOWVEN uFlamer X1800, we wish it will bring you lots of exciting moments.

Please read the following manual carefully before operating this product.

▲ Warning

- ∨ This product is only suitable for qualified or skilled operators who has experience with the technology of the device and is particularly informed about the types of fuel used by the device.
- ∨ Unauthorized repair are prohibited, it may cause serious incident.
- ∨ Make sure power supply is consistent with the rated voltage of the equipment, and the socket must be well grounded. Unplug and turn off the machine when not use.
- ∨ Before power on the machine, please check carefully the safety distance and make sure it meets the requirements in this manual.
- ∨ Please connect DMX cable before turn on the power supply, make sure communication command stay at non firing status, and safety switch of X1800 stay at TEST MODE.
- ∨ After turning on the device, no person allows to stay in the danger area. Ensure all persons that are part of the show be informed about the safety distance, risks and functions of the device.
- ∨ Always have a CO₂ fire extinguisher and an extinguishing blanket in case of needed.
- ∨ If there be any doubt as to the safety operation of the device in any circumstances, the device should be taken out of service immediately. Be sure the device is in good operating condition before use. If fail to fire correctly, immediately shut down and check it accordingly. Any questions please always contact SHOWVEN (info@showven.cn) for help.
- ∨ Be sure to use high quality flame fluid according to below requirement, otherwise, it is easily leads to failure or danger.
- ∨ The operator responsible for the control of uFlamer X1800 must always have a clear view of the device, so that he/she can stop the show immediately when there is danger. The main AC power switch should be near operator. So that operator can turn off the power of all devices in case of abnormal.
- ∨ The device shall not be altered and applied to other use purpose.

▲ Disclaimers:

SHOWVEN technologies Co., Ltd excludes liability for unsafe situations, accidents and damages resulting from:

1. Ignoring warnings or regulations as shown on uFlamer X1800 or this manual.
2. Use for other applications or circumstances other than those indicated herein.
3. Changes to the uFlamer X1800, including use of non-original spare parts, lack of maintenance etc.
4. Dismantling uFlamer X1800 without authorization from SHOWVEN.
5. Use this machine by unqualified or untrained personnel.
6. Use other type of fuel instead of ISOPAR as indicated in this manual.
7. Improper use of machine.

▲ Functional Characteristics

- ∨ 210° swivel angles
- ∨ Waterproof design, can be used in rain
- ∨ Dual solenoid valve for extra safety
- ∨ Dual igniter ensure successful ignition
- ∨ 88 preset firing sequences, easy to operate
- ∨ Support 9-60V pyro signal

- \ Flames up to 10m
- \ Stainless steel housing
- \ Built-in accumulator
- \ DMX control, both 3-pin and 5-pin XLR

▲ Technical Specifications

- \ **Model:** uFlamer X1800
- \ **Dimension:** 370×380×380mm
- \ **Weight:** 19 kg
- \ **Input:** 220V, 110V
- \ **Quick Coupler:** ISO7241B G1/4 male
- \ **Work Power:** 260W
- \ **Usage in Rain:** YES
- \ **Work Pressure Range:** 8-12Bar
- \ **Installation Angles:** Any direction, bottom plate need protective cover to achieve waterproof function
- \ **Fuel:** ISOPAR L
- \ **Accumulator:** YES
- \ **Flame Height:** 8-10m(Nozzle M)
- \ **Ignition:** Dual, high voltage electron ignition
- \ **Fuel Consumption:** 60ml/s (Nozzle M), 30ml/s (Nozzle L)
- \ **Control:** DMX , 9-60V pyro signal
- \ **Min. Firing Duration:** 0.1S
- \ **Firing Angle.:** 210° (±105°)

▲ Structure

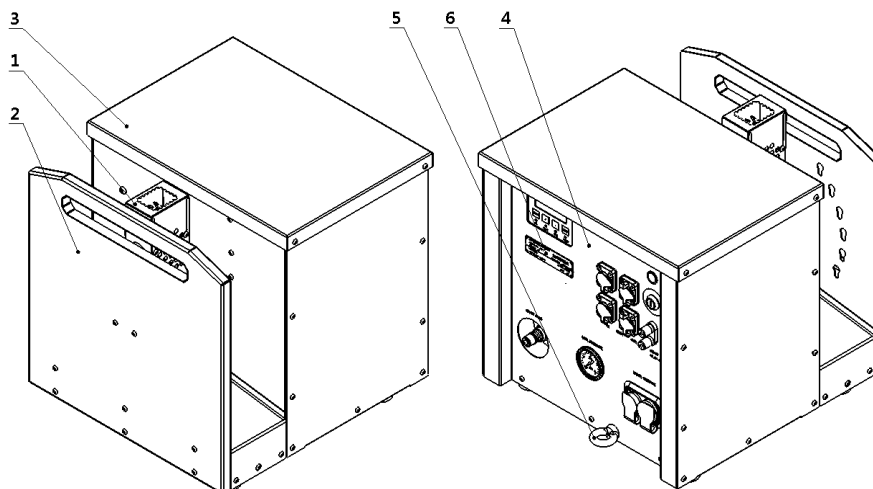

1. Flame chamber
2. Front Panel
3. Top Panel
4. Rear panel
5. Safety loop
6. Label

Diagram of bottom panel

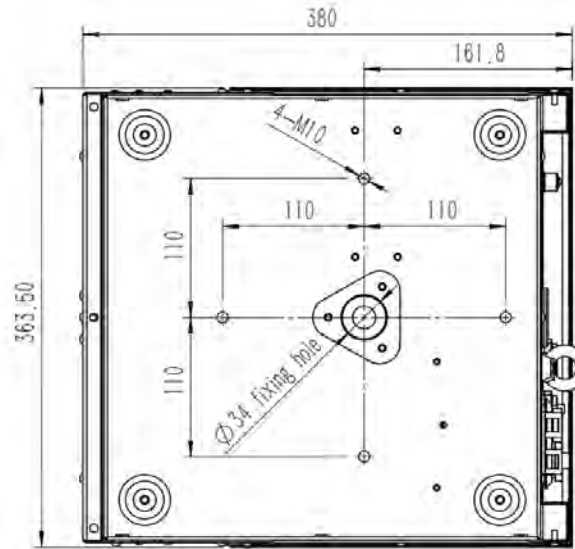

Rear Panel



1. Display area
2. Pressure gauge
3. Fuel IN quick coupler (ISO7241B G1/4 male) (Fuel input pressure 8-12bar)
4. Pressure indicator light
5. 3-PIN DMX
6. Safety switch
7. 5-PIN DMX
8. 9-60V pyro signal port
9. Power IN / OUT

▲ Operation Panel

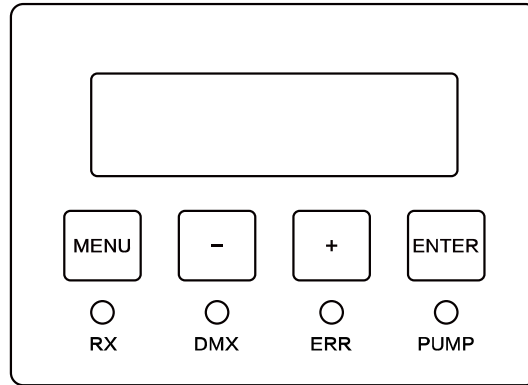

1. LED Display Area

- RX : Radio receiving (reserved)
- DMX : DMX signal. Flash means DMX signal available, otherwise no DMX signal
- ERR : Light on when there is an error
- PUMP : Indicate light (reserved)

2. Button Functions:

- MENU : Switch interface to setup parameter;
 - + : Parameter Up
 - : Parameter Down
 - ENTER : Confirm and save parameters (screen will flash when parameters saved)
- Note: screen display will switch to main interface if don't press button in 10s.*

3. Pressure Indicator Light Status Explanation

Status	Pressure
OFF	Current Pressure < P. Low Limit
ON	P. Low Limit ≤ Current Pressure < P. Upper Limit
BLINK	P. Upper Limit ≤ Current Pressure

4. Welcome Interface

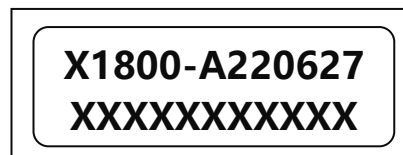

- First Line: Product model and software version
- Second Line: Equipment series number

5. Main Interface

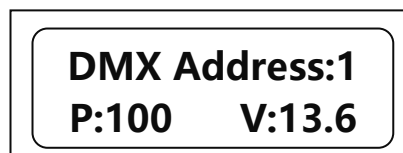

- First Line: DMX address;
- Second Line: Pressure 100 (e.g. 100=10bar); V: 13.6 means internal voltage is 13.6V.

6. Alert Message

Alert Message	Why it appears	How to remove
E0 Invert On	Invert function ON	Set Invert to OFF
E0 Test Mode	Safety Switch at TEST MODE	Switch to USER MODE
E0 Factory Mode	Factory mode	Switch to Normal mode
E0 MotorDisable	Motor Disabled ON	Set Motor Disabled to OFF
E0 FireForbidden	Fire Forbidden ON	Set Fire Forbidden to OFF
E4 ExtIgnite ON	Ext Ignite ON	Set Ext Ignite to OFF

7. Error Message

Error Message	Why it appears	How to remove
E5 Voltage Err	DC input < 10V or > 15v	Make sure DC input between 10-15V
E6 Tip Err	Machine slant over 45°, it stops running	Tip setting set to OFF, or horizontal install machine.

8. Interface setup

Press "MENU" to switch through setup menu

Menu	Range	Default	Explanation
Set DMX Address	1~512	1	DMX address setup
Angle Limit	MAX NO.1 - NO.15	MAX NO. 15	Restrict nozzle rotate angles: Set by "+" and "-", and confirm by "ENTER"
	MIN NO.1 - NO.15	MIN NO. 1	

Steps setting the angle limit and install angle blocks.

- Set the "Maxi. Angle" and "Mini. Angle", press "ENTER" to save the changes.
- Test the SEQUENCE 31 or push the CH1 DMX value from 0 to 255 on DMX console to drive flame nozzle movement manually, confirm the nozzle is waving only in the preset limited angles instead of from -105° to +105°. If not, please reset the ANGLE LIMIT and check. (SEQUENCE 31 of X-F3600 is short flame step sequence from -105° to +105°, after set the angle limit, it can only waving between the Mini. Angle and Maxi. Angle).
- After confirm the software angle limit control works well, then install the angle block plate and put angle limit rod at corresponding Mini. Angle and Maxi. Angle. Test sequence 31 again to reconfirm the angle limit rod was correctly installed.

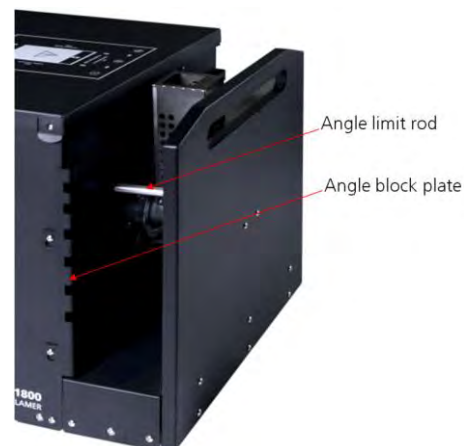
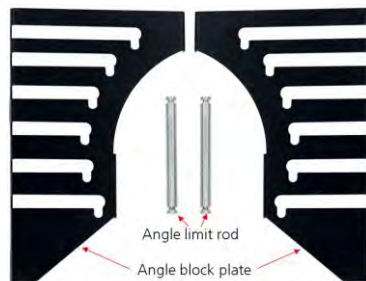

9. Advanced Interface

Press "MENU" 3s enter advanced interface, press "MENU" to switch interface, press "MENU" 3s can back to main interface.

Items	Contents	Default	Description
Drive Test	OFF / Motor / Igniter / Jet Valve 1 / Jet Valve 2		
	1. Motor		Swiveling and stop at target angle.
	2. Igniter		Ignite 1s
	3. Jet Valve 1 4. Jet Valve 2		Safety lock located at user mode, pressure release valve on, then related jet valve will be on and off for 3 times
Ext Ignite	OFF / ON	OFF	Trigger through 9-60V pyro ignition signal
Set Ext Sequence	1~88	OFF	Preset sequence triggered by pyro signal
语言 (Language)	English / Chinese	English	Language switch
Mode Select	Normal Mode / Factory Mode	Normal Mode	Factory mode is for test in factory only
Tip Setting	OFF / ON	OFF	Turn ON/OFF tip over function
Head to middle	OFF / ON	OFF	Channel 1=0, Firing head will remain in middle position (NO.8) after running a preset sequence.
Invert	OFF / ON	OFF	When turned on, all angles will be mirrored.
Motor Disabled	OFF / ON	OFF	When turned on, the position of the firing head should be moved or set manually, and the motor of firing head will be disabled. (The flamer should be restarted before it takes effect.)
DefaultParameter	OFF / ON	OFF	Reset default parameter settings

▲ Firing Angles

The firing angle for X1800 is $\pm 105^\circ$, from the Audience Side view, there are altogether 15 firing angles as below.

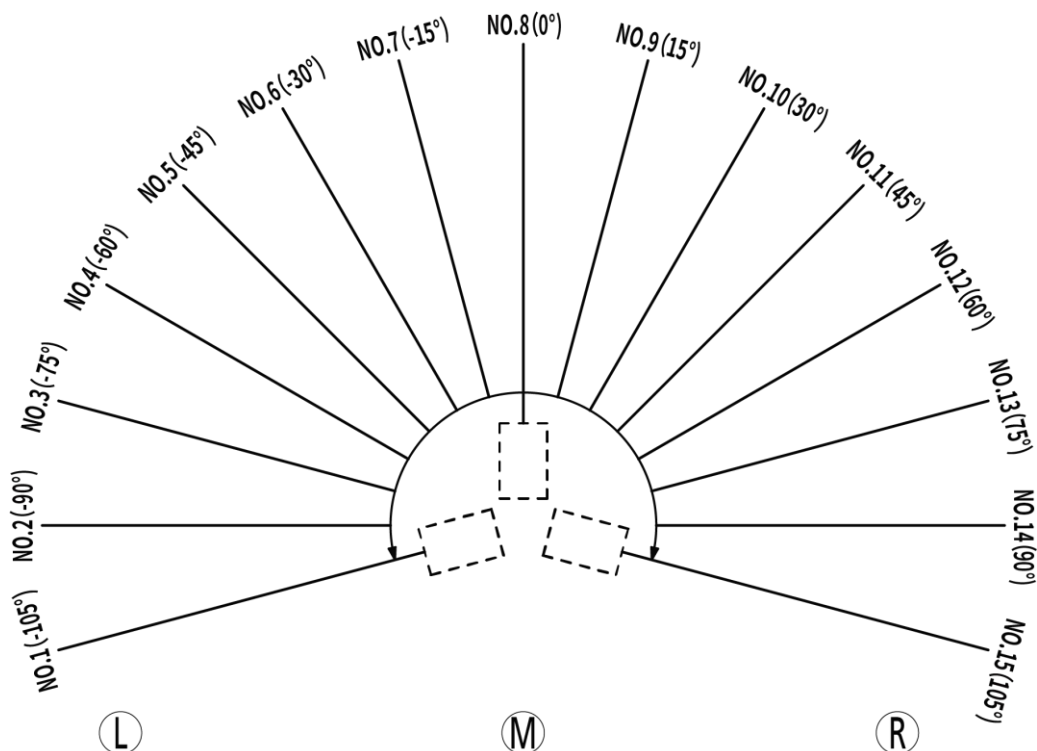

▲ Drive time for Effects

Time needed for the motor drive from NO.8 to relevant angle.

No.	Angles	Drive time needed
NO.1	-105°	170ms
NO.2	-90°	150ms
NO.3	-75°	130ms
NO.4	-60°	110ms
NO.5	-45°	90ms
NO.6	-30°	70ms
NO.7	-15°	50ms
NO.8	0°	0ms
NO.9	15°	50ms
NO.10	30°	70ms
NO.11	45°	90ms
NO.12	60°	110ms
NO.13	75°	130ms
NO.14	90°	150ms
NO.15	105°	170ms

For example for the motor drive from 0° to 45°, it need 90ms, when operator design a show to synchronize to music, this drive time must be calculated.

▲ uFlamer X1800 Firing Sequences

uFlamer X1800 has 88 preset sequences, operator use related channel DMX value or sequence No. to access certain sequence. Below, you can find sequence list and single ignitions.

Single Ignition Sequence List

No.	Ignition angle	Description	Nozzle Movement	Firing Duration (For reference)	CH5 DMX Reference Value
1	-105°	Single Ignition SHORT flame	Static	0.19s	3-5
2	-90°	Single Ignition SHORT flame	Static	0.19s	6-7
3	-75°	Single Ignition SHORT flame	Static	0.19s	8-10
4	-60°	Single Ignition SHORT flame	Static	0.19s	11-12
5	-45°	Single Ignition SHORT flame	Static	0.19s	13-15
6	-30°	Single Ignition SHORT flame	Static	0.19s	16-17
7	-15°	Single Ignition SHORT flame	Static	0.19s	18-20
8	0°	Single Ignition SHORT flame	Static	0.19s	21-22
9	15°	Single Ignition SHORT flame	Static	0.19s	23-25
10	30°	Single Ignition SHORT flame	Static	0.19s	26-28
11	45°	Single Ignition SHORT flame	Static	0.19s	29-30
12	60°	Single Ignition SHORT flame	Static	0.19s	31-33
13	75°	Single Ignition SHORT flame	Static	0.19s	34-35
14	90°	Single Ignition SHORT flame	Static	0.19s	36-38
15	105°	Single Ignition SHORT flame	Static	0.19s	39-40
16	-105°	Single Ignition LONG flame	Static	0.56s	41-43
17	-90°	Single Ignition LONG flame	Static	0.56s	44-45
18	-75°	Single Ignition LONG flame	Static	0.56s	46-48
19	-60°	Single Ignition LONG flame	Static	0.56s	49-50
20	-45°	Single Ignition LONG flame	Static	0.56s	51-53
21	-30°	Single Ignition LONG flame	Static	0.56s	54-56
22	-15°	Single Ignition LONG flame	Static	0.56s	57-58
23	0°	Single Ignition LONG flame	Static	0.56s	59-61
24	15°	Single Ignition LONG flame	Static	0.56s	62-63
25	30°	Single Ignition LONG flame	Static	0.56s	64-66
26	45°	Single Ignition LONG flame	Static	0.56s	67-68
27	60°	Single Ignition LONG flame	Static	0.56s	69-71
28	75°	Single Ignition LONG flame	Static	0.56s	72-73
29	90°	Single Ignition LONG flame	Static	0.56s	74-76

30	105°	Single Ignition LONG flame	Static	0.56s	77-79
----	------	----------------------------	--------	-------	-------

Step Sequences List

No.	Ignition angle NO.	Description	Nozzle movement	Firing Duration (For reference)	CH5 DMX Reference Value
31	Step from 1-15	SHORT flame Step sequence	L -> R	2.66s	80-81
32	Step from 15-1	SHORT flame Step sequence	R -> L	2.66s	82-84
33	Step 5>8>11	SHORT flame Step sequence	L -> R	0.92s	85-86
34	Step 11>8>5	SHORT flame Step sequence	R -> L	0.92s	87-89
35	Step 6>10	SHORT flame Step sequence	L -> R	0.75s	90-91
36	Step 10>6	SHORT flame Step sequence	R -> L	0.75s	92-94
37	Step 4>6>8>10>12	SHORT flame Step sequence	L -> R	1.27s	95-96
38	Step 12>10>8>6>4	SHORT flame Step sequence	R -> L	1.27s	97-99
39	Step 8>6>10>4>12	SHORT flame Step sequence	M>L>R>L>R	1.60s	100-101
40	Step 8>10>6>12>4	SHORT flame Step sequence	M>R>L>R>L	1.60s	102-104
41	Step from 1-15	LONG flame Step sequence	L -> R	7.78s	105-107
42	Step from 15-1	LONG flame Step sequence	R -> L	7.78s	108-109
43	Step 5>8>11	LONG flame Step sequence	L -> R	1.82s	110-112
44	Step 11>8>5	LONG flame Step sequence	R -> L	1.82s	113-114
45	Step 6>10	LONG flame Step sequence	L -> R	1.25s	115-117
46	Step 10>6	LONG flame Step sequence	R -> L	1.25s	118-119
47	Step 4>6>8>10>12	LONG flame Step sequence	L -> R	2.68s	120-122
48	Step 12>10>8>6>4	LONG flame Step sequence	R -> L	2.68s	123-124
49	Step 8>6>10>4>12	LONG flame Step sequence	M>L>R>L>R	2.88s	125-127
50	Step 8>10>6>12>4	LONG flame Step sequence	M>R>L>R>L	2.88s	128-130

Wave Sequence List

No.	Ignition angle NO.	Description	Nozzle movement	Firing Duration (For reference)	CH5 DMX Reference Value
51	Wave 5 -->11	Middle wave sequence	L -> R	1.87s	131-132
52	Wave 11 -->5	Middle wave sequence	R -> L	1.87s	133-135
53	Big wave 1--15	LONG wave sequence	L -> R	4.08s	136-137
54	Big wave 15--1	LONG wave sequence	R -> L	4.08s	138-140
55	Wave 8-->1	Middle wave sequence	M -> L	2.09s	141-142
56	Wave 8-->15	Middle wave sequence	M -> R	2.09s	143-145
57	Wave 1-->8	Middle wave sequence	L -> M	2.31s	146-147
58	Wave 15-->8	Middle wave sequence	R -> M	2.31s	148-150
59	Wave 8-->11	SHORT wave sequence	M -> R	0.99s	151-152
60	Wave 8-->5	SHORT wave sequence	M -> L	0.99s	153-155
61	Wave 5-->8	SHORT wave sequence	L -> M	1.08s	156-158
62	Wave 11-->8	SHORT wave sequence	R -> M	1.08s	159-160

Additional Sequences List

No.	Ignition angle NO.	Description	Nozzle movement	Firing Duration (For reference)	CH5 DMX Reference Value
63	Step 3>13	SHORT flame Step sequence	L -> R	0.93s	161-163
64	Step 13>3	SHORT flame Step sequence	R -> L	0.93s	164-165
65	Step 3>13	LONG flame Step sequence	L -> R	1.63s	166-168
66	Step 13>3	LONG flame Step sequence	R -> L	1.63s	169-170
67	Step 8-13	SHORT flame Step sequence	M -> R	1.55s	171-173
68	Step 13-8	SHORT flame Step sequence	R -> M	1.55s	174-175
69	Step 8-13	LONG flame Step sequence	M -> R	3.24s	176-178
70	Step 13-8	LONG flame Step sequence	R -> M	3.24s	179-181
71	Step 8-3	SHORT flame Step sequence	M -> L	1.54s	182-183
72	Step 3-8	SHORT flame Step sequence	L -> M	1.54s	184-186

73	Step 8-3	LONG flame Step sequence	M -> L	3.24s	187-188
74	Step 3-8	LONG flame Step sequence	L -> M	3.24s	189-191
75	Step 3-13	SHORT flame Step sequence	L -> R	1.98s	192-193
76	Step 13-3	SHORT flame Step sequence	R -> L	1.98s	194-196
77	Step 2-14	SHORT flame Step sequence	L -> R	2.32s	197-198
78	Step 14-2	SHORT flame Step sequence	R -> L	2.32s	199-201
79	Step 8>5>11	SHORT flame Step sequence	M>L>R	0.93s	202-203
80	Step 8>11>5	SHORT flame Step sequence	M>R>L	0.93s	204-206
81	Step 5-11	SHORT flame Step sequence	L -> R	1.28s	207-209
82	Step 11-5	SHORT flame Step sequence	R -> L	1.28s	210-211
83	Wave 8-->13	Middle wave sequence	M -> R	1.70s	212-214
84	Wave 13-->8	Middle wave sequence	R -> M	1.70s	215-216
85	Wave 8-->3	Middle wave sequence	M -> L	1.60s	217-219
86	Wave 3-->8	Middle wave sequence	L -> M	1.60s	220-221
87	Wave 3-->13	LONG wave sequence	L -> R	3.06s	222-224
88	Wave 13-->3	LONG wave sequence	R -> L	3.06s	225-226
>89	8(0°)	Single Ignition LONG flame	Static	max. 8s	227-255

▲ DMX CONTROL

Channel	Function	Value
CH1	Manual Angle setup	0~255: angle change from -105° to 105° 128: straight upward (0°)
CH2	Manual Nozzle Waving Speed setup	0 and 255: Max Speed 1~254: Speed increase
CH3	Ignition ON/OFF	0~253: Ignition OFF 254~255: Ignition ON
CH4	Firing Duration setup	0 and 255: permanent fire (10s is limit duration time) 1~254: 10~2540ms duration time (Manual firing duration = DMX Value * 10ms)
CH5	Program sequence setup	0-2: no preset sequence 3-255: preset sequence DMX value = 2 + Sequence No. * 2.55 (ROUND OFF)
CH6	Mode setup	0~49: Firing OFF (Emergency Stop) 50~200: Firing ON 201~255: Firing OFF (Emergency Stop)

Channel 1 (CH1): Manual Angle Setup

Angle No.	Angle	DMX Value
1	-105°	0
2	-90°	18
3	-75°	36
4	-60°	54
5	-45°	73
6	-30°	91
7	-15°	109
8	0°	128
9	15°	146
10	30°	165
11	45°	183
12	60°	201
13	75°	219
14	90°	237
15	105°	255

1. The first channel controls the firing angle. It defines to which angle the nozzle of CIRCLE FLAMER move to. The angle can be chosen anywhere between -105° to +105° (DMX value 0 to 255)

2. The DMX value for angle of 0° is 127.5 (round up 128). Use this value, following formula can be used to calculate all other angles \angle in degree. Please always note the prefix of the angle

$$\text{DMX Value} = 127.5 + (\angle * 1.2145)$$

Channel 2 (CH2): Manual Nozzle Waving Speed Setup

CH2: Nozzle Waving Speed Setup			
DMX Value	0	1-254	255
Speed	Max Speed	Incremental of Speed	Max Speed

The second channel defines the nozzle waving speed. It work together with Channel 1 for manual firing

Channel 3 (CH3): Ignition ON/OFF

CH3: Ignition		
DMX Value	0-253	254-255
Ignition	Igniter disable (ignition OFF)	Igniter enable (ignition ON)

The third channel activates the actual ignition. If the DMX value of this channel higher than 253, the CIRCLE FLAMER will ignite.

Channel 4 (CH4): Firing Duration setup

CH4: Manual Firing Duration setup								
DMX Value	0	1	2	3	4	254	255
Firing Duration	Permanent	10ms	20ms	30ms	40ms	2540ms	Permanent

The fourth channel is the firing duration setup

Below formula can be used to calculate the firing duration (ms):

$$\text{DMX Value} = t/10$$

Channel 5 (CH5): Program Sequence setup

The fifth Channel allows to firing a preset sequence. Three DMX values can be used for one of the programmed firing sequence from above sequence list (refer to above sequence list table).

Below formula can be used to calculate firing sequence:

$$\text{DMX Value} = 2 + \text{Sequence No.} * 2.55$$

CH5: Sequence List							
DMX Value	0~2	3~5	6~7	8~10	11~12	225-226
Sequence No.	N/A	1	2	3	4		88

Channel 6 (CH6): Mode setup

The sixth channel is the working mode.

CH6: Mode setup			
DMX Value	0-49	50-200	201-255
Mode	Firing OFF	Firing ON	Firing OFF

▲ Operation

1. Safety Distance

Definition and Instructions

Safety distance for uFlamer X1800 divided into two parts safety radius around machine (a) and safety distance at firing direction (b). No person and flammable materials are allowed to stay inside the safety zone when flamer was armed.

The safety radius around machine depends on the firing height (nozzle size), with a radius from 2.5m to 3m.

For safety distance at firing direction equals to maximum firing height * 1.5. uFlamer X1800 with maximum $\pm 105^\circ$ waving firing angles, when firing step sequence, wave sequence or additional sequences the safety zone is a three-dimensional sector area.

Nozzle Type	Max. Flame Height	Safety Radius around uFlamer X1800 (a)	Safety Distance at Firing Direction (b)
SFSMA002 Nozzle M	10m	3m	15m
SFSMA003 Nozzle L	8m	2.5m	12m

The uFlamer X1800 safety zone is a three-dimensional space with a cross-section of 210° sector enclosed by a and b (check below diagram). We can understand it as a safety area formed by a safety column with diameter of a, height of b rotate of ± 105 degrees. Unauthorized persons and objects are strictly prohibited from entering. Depending on the firing sequence / angles the sector area changes accordingly.

For angled installation, the safety distance both around machine and firing direction should shift accordingly.

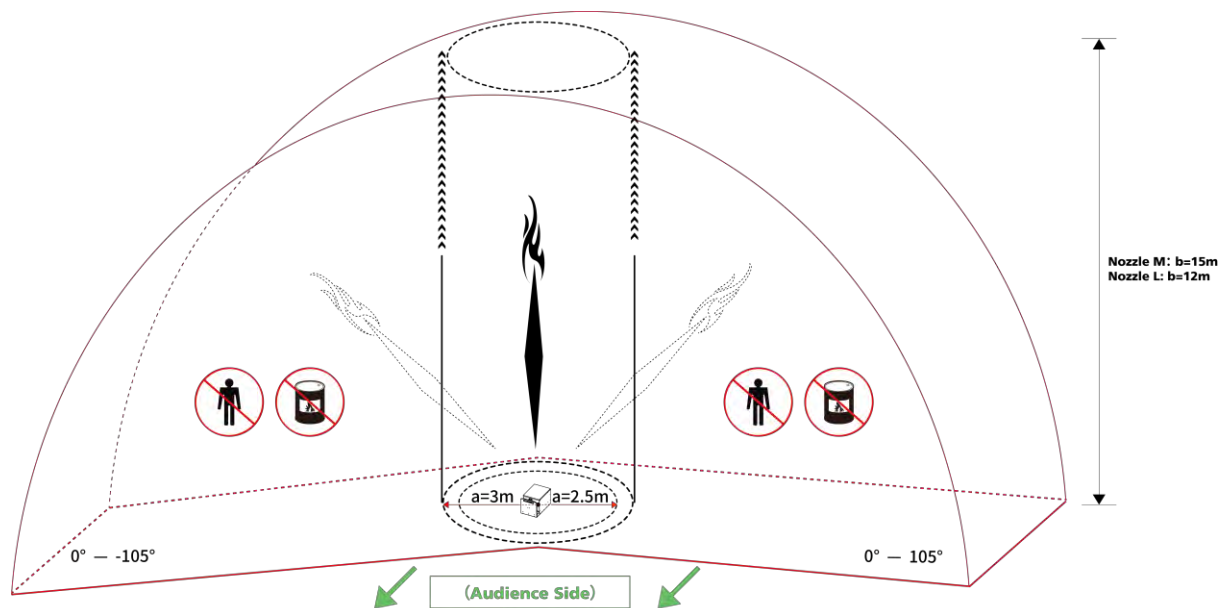

Safety distance in windy environment

The safety zone radius (a) and safety distance of firing direction (b) increase with wind direction and wind speed (v, m/s). The safety distance in windy conditions can be calculated as below:

For Nozzle M: $a = 3 + v$; $b = 15 + v$

For Nozzle L: $a = 2.5 + v$; $b = 12 + v$

For example when the wind speed is 3m/s, we use the Nozzle M on uFlamer X1800, then the safety zone radius should be 6m, safety distance of firing direction is 18m.

When the wind speed ≥ 8 m/s (wind force ≥ 5), please use it with caution. When wind speed ≥ 17 m/s (wind force ≥ 8), please stop use uFlamer X1800.

Direction Explanation



There is direction explanation on top panel of uFlamer X1800 as show above picture.

1. 1 to 15 is the firing angle of X1800, Far Right is position 15, Middle is position 8, Far Left is position 1.
2. Audience side and control side are indicated in above picture.

Note: in order to indicate correct direction, please place the top panel correctly.

Fuels for uFlamer X1800



1. Water content in fuel should less than 0.5%
2. For maximum safety, please use fuel with flash point between 60-80°C, ISOPAR L is highly recommended.

SHOWVEN excludes liability for the losses, damages and accidents caused by not using qualified fuels in accordance with this requirement.

Always have a dry powder fire extinguisher, a CO₂ fire extinguisher and an extinguishing blanket next to the equipment in case of needed. And someone must be on duty during operation. In case accident occurs, a dry powder fire extinguisher can be used when the fire is large, and a carbon dioxide fire extinguisher can be used when the fire is small.

2. Install uFlamer X1800 and Pump Station

- a) Choose the correct nozzle, ensure the installation position of uFlamer X1800 meet above safe distance requirements. New uFlamer X1800 supplied with a nozzle M which generate up to 10m flame.
- b) Pump station can only be installed horizontally on a firm level surface. The installation place must be well ventilated, do not install it in the open air or in a confined space. The equipment must be far away from heat sources, fire sources, and objects that can cause fire. Always have a dry powder fire extinguisher, a CO₂ fire extinguisher and an extinguishing blanket next to the equipment in case of needed. In case accident occurs, a dry powder fire extinguisher can be used when the fire is large, and a carbon dioxide fire extinguisher can be used when the fire is small.
- c) uFlamer X1800 can be installed in any direction, be aware the bottom panel of uFlamer X1800 is not waterproof if need installed in angles or upside down please install bottom panel waterproof shield (RMSTE1062, optional part).

- d) Make sure uFlamer X1800 is securely installed. For truss installations always connect with safety rope to ensure extra safety. If there is any other national or regional guidelines please follow it accordingly.
- e) Double confirm the machine are firmly installed.

3. Hose connection between flame head X1800 and pump station

According to the position of flame heads and pump station, various connection methods can be flexibly adopted. Below are some examples.

- a. Pump Station uPumper P20 – Main hose – Fuel dispenser – Branch hose – uFlamer X1800

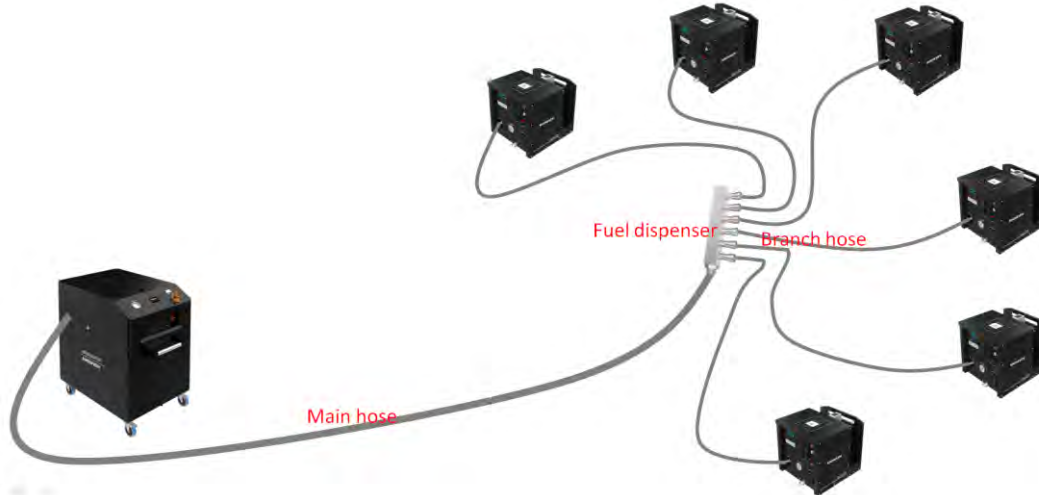

- b. Pump Station uPumper P20 – Main hose – T-shape dispenser – Branch hose – uFlamer X1800

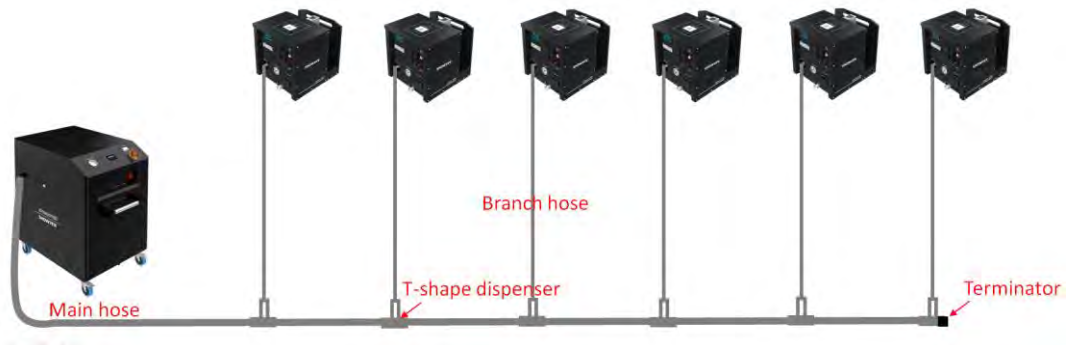

- c. Pump Station uPumper P4 – Main hose – T-shape dispenser – Branch hose – uFlamer X1800

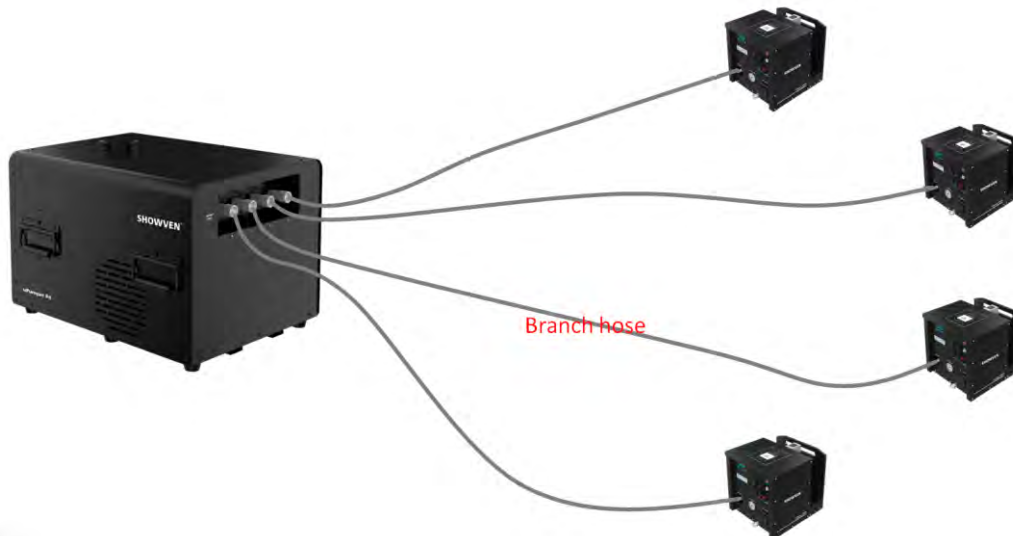

4. Power and DMX cable Connection for flame head

Before power and/or DMX cable connection, make sure safety lock of uFlamer X1800 stay at TEST MODE.

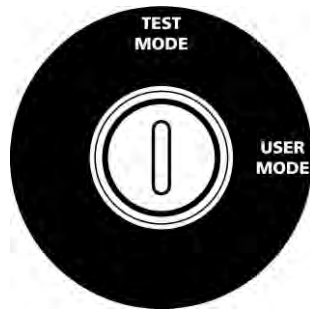

If control by DMX, follow below steps:

- a) Connect a power cable to the POWER IN socket of uFlamer X1800. Connect the other end of power cable to the power source. Make sure power supply is consistent with the rated voltage of the equipment, and the socket must be well grounded.
- b) Each unit of uFlamer X1800 can be connected to power supply directly. If connecting machines in sequence, please connect a power link cable to the POWER OUT of the previous machine, connect the other end of the power link cable to POWER IN of the next machine. Do not connect more than one unit to a single electrical circuit.
- c) Power on all uFlamer X1800
- d) Assign DMX address for each unit of X1800. If using SHOWVEN host controller or FXcommander to control the machine, please allocate a unique DMX address for each unit of machine.
- e) Connect a DMX cable to the DMX IN socket of the first unit of X1800, another head of this DMX cable connects to the pump station DMX OUT. If the pump station is controlled separately, please connect the other head of this DMX cable to the DMX console (such as FXcommander).
- f) Connect a DMX cable to the DMX OUT socket of the previous X1800, and the other end to the DMX IN of the next machine. Connect all devices in series in this way.
- g) Suggest plugging a DMX terminator into the DMX OUT of the last unit of machine to improve signal reliability. A signal amplifier is required for long distance (>200m) DMX signal transmission.

If control by 9-60V pyro signal, follow below steps:

- a) Connect a power cable to the POWER IN socket of uFlamer X1800. Connect the other end of power cable to the power source. Make sure power supply is consistent with the rated voltage of the equipment, and the socket must be well grounded.
- b) Each unit of uFlamer X1800 can be connected to power supply directly. If connecting machines in sequence, please connect a power link cable to the POWER OUT of the previous machine, connect the other end of the power link cable to POWER IN of the next machine. Do not connect more than one unit to a single electrical circuit.
- c) Power on all uFlamer X1800
- d) Set the Ext Ignite to ON status in the advanced interface, set the firing sequence by choosing a sequence No. at Set Ext Sequence.
- e) Connect the power control cables to the 9-60V pyro signal connector on uFlamer X1800.
- f) Connect the other end of power control cables to the pyro controller (9-60V external trigger source).
Make sure the pyro controller is powered off.

5. Power and DMX connection for Pump Station

- a) Connect a power cable to the POWER INPUT of Pump Station. Connect the other end of power cable to the power source. Make sure power supply is consistent with the rated voltage of the equipment, and the socket must be well grounded.
- b) Connect a DMX cable to the DMX IN socket of Pump Station, the other head of this DMX cable connects to DMX console (such as FXcommander).
- c) Power ON the Pump Station and DMX console

6. Programming

Program the uFlamer X1800 with DMX console.

7. Test the ignition function of Flame head uFlamer X1800

Test the ignition function of uFlamer X1800, we can check whether the igniters of each unit of X1800 are working fine. Due to the safety switch, it stays at TEST MODE and the pump station is under depressurized status, there will be only ignition while no fuel spray out, so no flames are generated.

8. Fill the Pump Station

Please fill the pump station with qualified fuel.

- a) Water content in fuel should be less than 0.5%

- b) The fuels should meet the requirements of both flame head uFlamer X1800 and pump station.
- c) uPumper P20 can only use fuel with flash point between 60-80°C, ISOPAR L is highly recommended. ISOPROPANOL, Ethanol etc highly flammable fuels are forbidden to use on uPumper P20.

9. Pressurize

Pressurize the pump system through DMX console, we can check the pressure through pressure gauge on both pump station and flame head uFlamer X1800. The working pressure range for uFlamer X1800 is 8-12bar. We can check whether pump station are work normally and hose connection are well connected through this step.

Once confirmed very thing is fine, depressurize the whole system.

10. Firing

- a) Double confirm the prescribed safety zone is clear, no person, animal or other property within in this region.
- b) Switch the safety switch of uFlamer X1800 to USER MODE.

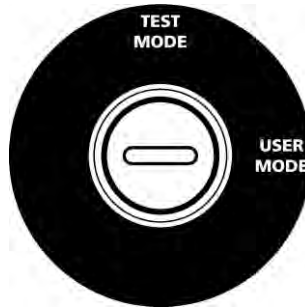

- c) Activate the pump station and pressurize for uFlamer X1800.
- d) Firing, the operator should always have a clear view of the device, so that he/she can stop the show immediately when there is danger.

11. Depressurize

Depressurize the system after use or if not use for a long time during the show we also suggest to depressurize to ensure the safety.

12. Power OFF

- a) Power OFF the pump station and DMX console after show
- b) If need to disassemble the installation, please disconnect the fuel supply between pump station and hose.
- c) Switch safety switch of uFlamer X1800 to TEST MODE
- d) Power OFF uFlamer X1800
- e) Disconnect power cable, DMX cable and hose connections.

▲ Nozzle Replacement

Use 14mm outer hexagon socket wrench to disassemble the nozzle, clean the nozzle and nozzle socket with air gun (air compressor), change a different nozzle and install it.

Nozzle disassemble tool: SFMET944



▲ Igniter Position Adjustment

Whenever changed the nozzle or ignition is not good, please check igniter pole position according to below parameters. The right position for each pair of pole should have a gap from tip to tip of $4\pm 0.5\text{mm}$ and a gap between two igniter of $13\pm 1\text{mm}$. Check the ignition success rate after adjustment by firing.

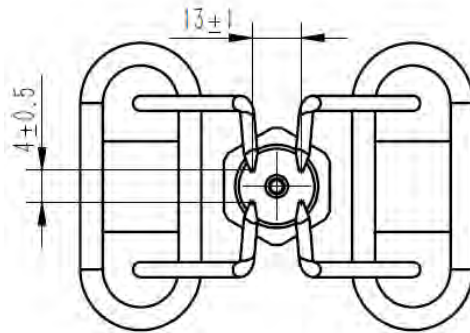

Note: Do unplug the power cable when service flamer.

▲ Maintenance

1. To maintain the system in good performance and running status, it is recommended to running the device at least once per month.
2. Check the ignition probes both before and after each show, if there is any foreign objects on it please clean it up.
3. Maintenance of the nozzle: Nozzle needs to be cleaned from time to time, and it is recommended that once every six months (depending on the environment and frequency of use). In the process of using the equipment, if the flame shape is seriously deformed or the fuel injection line is significantly deformed or coarsened, the nozzle should be removed immediately for cleaning. If after clean, there are still problems please replace new nozzle.
4. Maintenance of the O-ring: If it is found that the O-ring of the nozzle is damaged or ageing when cleaning the nozzle, the O-ring should be replaced in time (material and size of O-ring: fluororubber O-ring, the outermost diameter is 14 mm, and the line diameter is 2 mm).

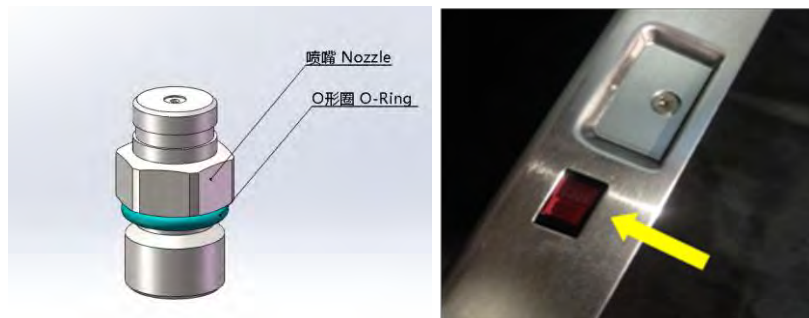

5. Switchable power input design, switchable between 110V and 220V as show above picture (voltage will show on it). The power supply is located on the side of the electric control, and you should remove the cover before switch it.

▲ Optional Parts for uFlamer X1800

Part. No.	Description	pcs / unit
RMWAS025	O ring for nozzle	1
RMBOT036	Safety ring	1
RMMET045	Safety rope	1
RMEMD062	Wireless receiver (for wireless control with FXcommander)	1
SFSMA002	nozzle M	1
SFSMA003	nozzle L	1
SFMET944	Nozzle disassemble tool	1
RMSMA215	Angle block assembly	2
RMSTE472		1
RMSTE473		1
SFCAB065	Waterproof DMX cable, 6m	1
RMSTE1062	X1800 bottom plate waterproof cover	1

▲ Warranty Instructions

- ∨ Sincere thanks for your choosing our products, you will receive quality service from us
- ∨ The product warranty period is one year. If there are any quality problems within 7 days after shipping out from our factory, we can exchange a brand new same model machine for you
- ∨ We will offer free of charge maintenance service for machines which with hardware malfunction (except for the instrument damage caused by human factors) in warranty period. Please don't repair machine without factory permission

Below situations NOT included in warranty service:

- ∨ Damage caused by use unqualified fuels;
- ∨ Damage caused by improper transportation, usage, management, and maintenance, or damage caused by human factors;
- ∨ Disassemble, modify or repair products without permission;
- ∨ Damage caused by external reasons (lightning strike, power supply etc.)
- ∨ Damage caused by improper installation or use;

For product damage not included in warranty range, we can provide paid service.

Invoice is necessary when applying for maintenance service from SHOWVEN

SHOWVEN[®]

PREMIUM FACTORY SAS - DISTRIBUTEUR OFFICIEL
1 Route Neuve, 71710 MONTCENIS - FRANCE Office
+33 805 69 13 27 | +33 608 630 452
info@premiumfactory.eu | www.premiumfactory.eu