

**SHOWVEN®**

# **USER MANUAL**

## **uFlamer Volcano**

V1.0



**Showven Technologies Co., Ltd**

# USER MANUAL

## uFlamer Volcano

- ★ Please read this manual carefully before operating this product.
- ★ Warranty card attached in the manual, please keep it well.

### ▲ Warning

- Unauthorized repair are prohibited, it may cause serious incident.
- Make sure power supply in consistent with the rated voltage of the equipment, and the socket must well grounded. Unplug and turn off the machine when not use.
- Before connect the power cable, communication DMX cable should well connected and ensure the command keep at firing OFF status. And safety lock stay at test mode.
- The device can only be placed horizontally. Safety distances are marked on the device (at least 15m in all projection directions, at least 10m to the other sides of the device).
- After turning on the device, no person allows to stay in the danger area. Ensure all persons that are part of the show be informed about the safety distance, risks and functions of the device.
- Always have a CO2 fire extinguisher and an extinguishing blanket in case of needed.
- If there be any doubt as to the safety operation of the device in any circumstances, the device should be taken out of service immediately. Be sure the device is in good operating condition before use. If fail to fire correctly, immediately shut down and check it accordingly. Any questions please always contact SHOWVEN (info@showven.cn) for help.
- Be sure to use high quality flame fluid, otherwise, it is easily lead to failure or danger. Be careful when refill the flame fluid tank. Please keep flame fluid away from heat source, sparks, fire or other possibility of ignition. Do not smoke!
- The operator responsible for the control of uFlamer Volcano must always have a clear view of the device, so that he/she can stop the show immediately when there is danger. The main AC power switch should near operator. So that operator can turn off the power of all devices in case of abnormal.
- The device shall not be altered and applied to other use purpose.

### Disclaimers:

SHOWVEN technologies Co., Ltd excludes liability for unsafe situations, accidents and damages resulting from:

1. Ignoring warnings or regulations as shown on flamer or this manual.
2. Use for other applications or circumstances other than those indicated herein.
3. Changes to the flamer, including use of non-original spare parts.
4. Removed safety cover without authorization from SHOWVEN.
5. Use this machine by unqualified or untrained personnel.
6. Improper use of machine.

## ▲ Foreword

Thanks for choosing SHOWVEN uFlamer Volcano. Please read following manual carefully and completely before operating this product. Operate according to instructions is very important for safety, and can elongate the service life of the machine.

Strictly follow the instruction in the manual when operate uFlamer Volcano. If you have any doubts, please contact SHOWVEN technologies Co., Ltd by info@showven.cn.

We assume the person who use or come in contact with the device are familiar with how the device should be handled. This includes proper use, maintenance and repair of the machine as defined in this user manual.

## ▲ Functional Characteristics

- \ 5-heads liquid flamer
- \ Independent control of each head
- \ Internal pump, plug and play system
- \ Flames up to 10m
- \ Reinforced stainless steel housing
- \ 25L built-in stainless steel fuel tank
- \ Support automatic refueling station
- \ Real-time fuel level display, both electronically and mechanically
- \ Safety switch key
- \ Integrated valve block design
- \ Premium and independent jet valve
- \ Customized water-proof ignitor
- \ IPX3 rain-proof, can be used in rainy day
- \ DMX control, with both 3-pin and 5-pin XLR port
- \ Compatible with fireworks firing system

## ▲ Technical Specifications

- \ DIMENSION: 630x460x405mm
- \ HOUSING MATERIAL: 304 STAINLESS STEEL
- \ WEIGHT:48Kg
- \ WORK POWER: 2000W
- \ INPUT:100-120V & 200-240V, 50/60Hz
- \ FLAMER HEIGHT: 8-10m
- \ FLAME ANGLES: 5 directions
- \ FUEL: ISOPAR, ISOPROPANOL, BIOETHANOL
- \ FUEL TANK CAPACITY: 25L
- \ FUEL CONSUMPTION: 60mL/s per nozzle
- \ WORK TEMP.: -20 °C to 50 °C
- \ INTERFACE: SEETRONIC 3-PIN & 5-PIN XLR  
NEUTRIK PowerCON TRUE1
- \ IGNITION: High voltage electron ignition
- \ CONTROL: DMX, 9-60V PYRO SIGNAL
- \ WATER PROOF LEVEL: IPX3

## ▲ Structure of uFlamer Volcano

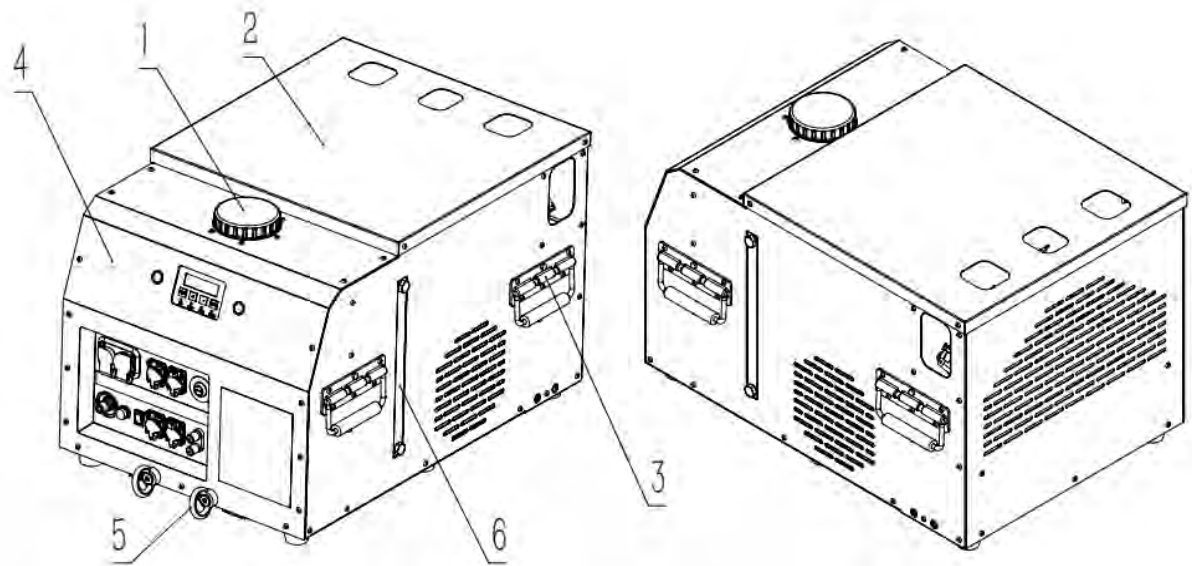

1. Fuel Tank Lid 2. Top Panel 3. Handle 4. Control Panel 5. Safety Loop 6. Level Gauge

## ▲ Connection dimension diagram of bottom bracket

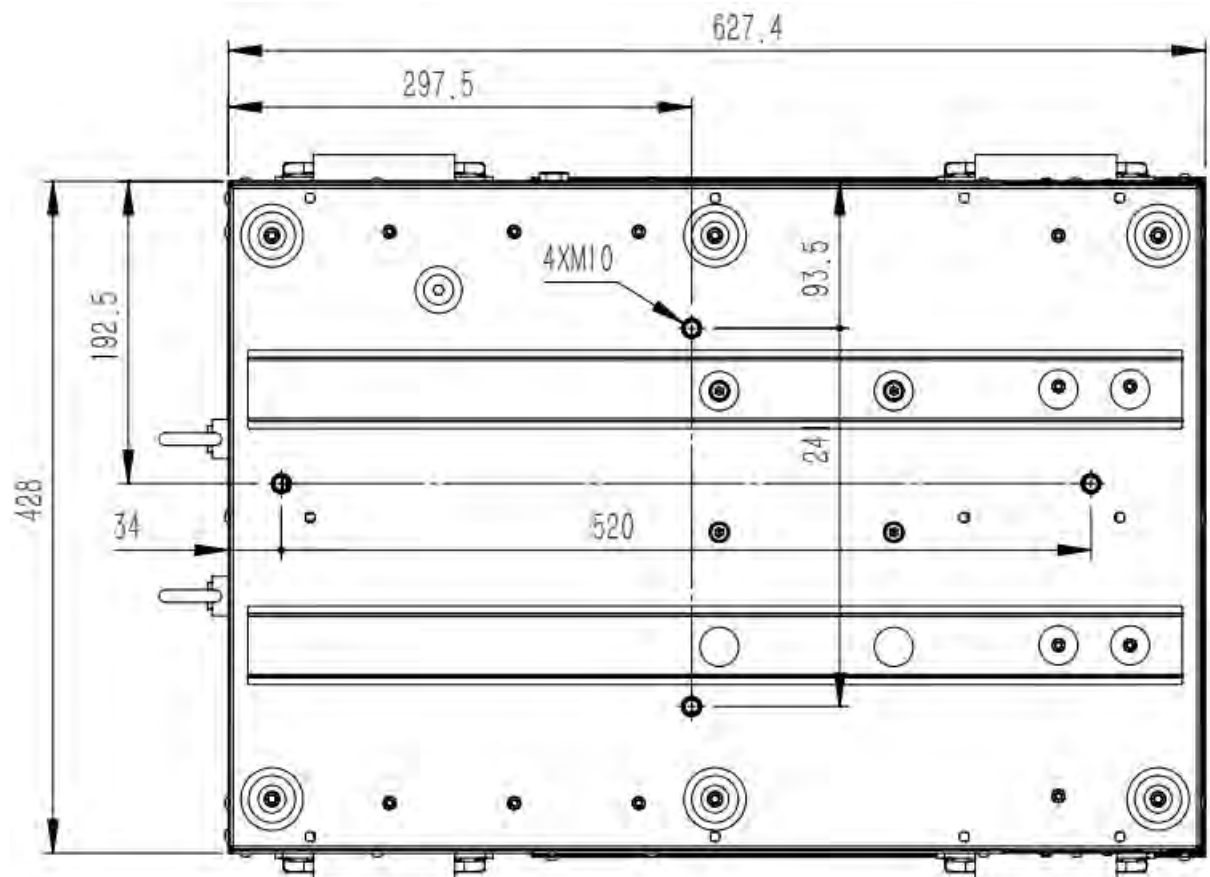

## ▲ Overview of Control Panel

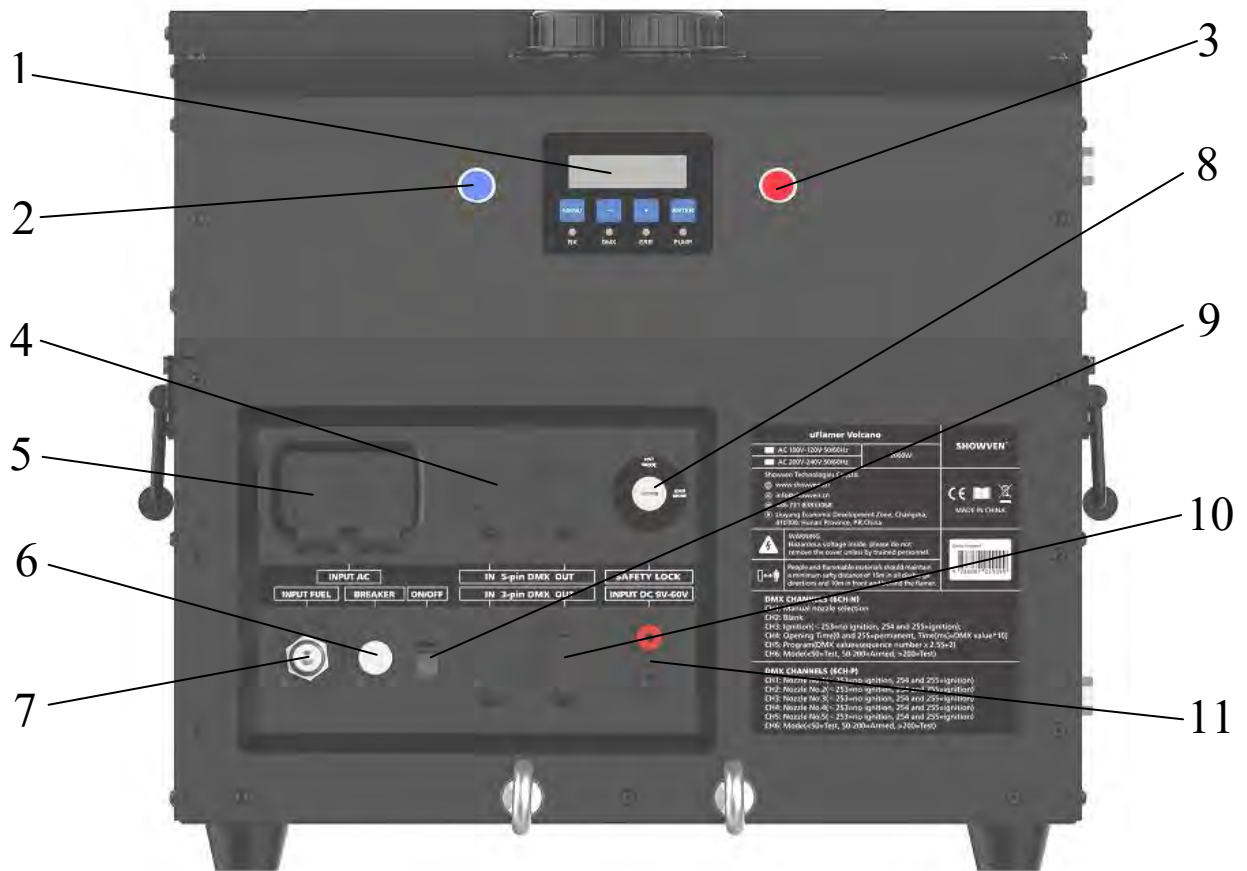

1. LCD screen operate panel
2. Pressure indicator
3. Safety indicator
4. 5-pin XLR Socket
5. 110V/220V Power Socket
6. Auto-reset Fuse
7. Fuel Input Quick Coupler (G1/4, ISO7241B)
8. Safety Lock
9. ON/OFF Switch
10. 3-pin XLR Socket
11. DC 9V-60V fireworks igniter signal port

## ▲ Operation Panel

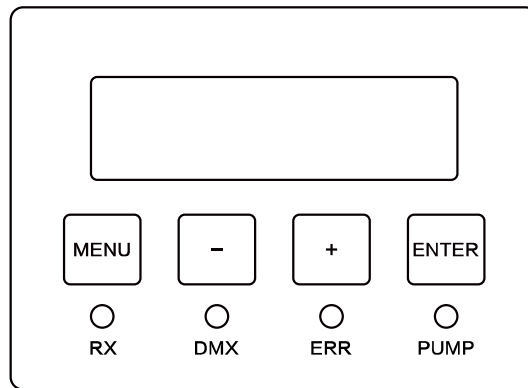

### 1. LED Display Area:

**RX:** Radio receiving (reserved)

**DMX:** DMX signal. Flash means DMX signal available, otherwise no DMX signal

**ERR:** Light on when there is an error

**PUMP:** Light on when pump is running

### 2. Button Functions:

**MENU:** Switch interface to setup parameter;

**+:** Parameter Up

**-:** Parameter Down

**ENTER:** Confirm and save parameters (screen will flash when parameters saved)

**Note:** screen display will switch to main interface if not press button in 10s.

### 3. Welcome Interface:



**Volcano202004**  
**F5-01207005**

**First Line:** Product model and software version

**Second Line:** Equipment series number

### 4. Main Interface:



**DMX: 1 M: 6CH-P**  
**P: 100 L: 50%**

**First Line**

**DMX:** DMX address 1(value from 1-512);

**M:** Channel Mode 6CH-P

**6CH-P:** professional channel mode;

**6CH-N:** normal channel mode

**6CH-S:** safety channel mode

**Second Line**

**P:** Pressure Value 100 (100=10bar)

**L:** Liquid level 50%

## 5. Alert Message:

Alert Message		Explanation
E0	Test Mode	Safety lock located at TEST MODE
	Factory Mode	DMX signal blocked in factory mode
	Invert ON	When turned on, all angles will be mirrored
	Prim Valve ON	Priming Valve is open
E1 Pressure Err	Pressuriser for about 13s, pressure value failed to reach 100%, system will report E1. Possible fault: No fuel, pump failure, pipeline problem etc.	
E2 P Relief Err	Pipeline can't release pressure leads to pressure relief error. Possible fault: pressure release valve failure, pipeline problem or control system problem etc.	
E4 Extlgnite ON	The Extlgnite Time is switched to ON	
E6 Tip Err	if the machine slant over 45°, it stops running, system will report E6	
E7 Low Fuel	When fuel ≤ 0, report E7 low fuel	

## 6. Interface setup:

### 1. 6CH Normal Mode / 6CH Pro Mode

Press "MENU" to switch through setup menu.

Menu	Range	Explanation
Set DMX Address	1~512	DMX address setup

### 2. 6CH Safe Mode

Press "MENU" to switch through setup menu.

Menu	Range	Explanation
Set DMX Address	1~512	DMX address setup
Safety Address	1~512	Safety Address

## 7. Advanced Interface:

Press "MENU" 3s enters advanced interface, press "MENU" to switch interface, press "MENU" 3s can back to main interface.

Menu	Contents	Explanation
Drive Test	OFF / Pump / Igniter / Relief Valve / Jet Valve	--
	1. Pump	Pump running 1s, if pressure reached the target value, the pump will not running. Keep safety Lock located at USER MODE before test.
	2. Igniter	Ignition from head No.1 to 5
	3. Relief Valve	Relief valve will be on and off 3 times
	4. Priming Valve	Priming Valve will on and off 3 times
	5. Jet Valve 1	6s after Relief Valve was on, related Jet Valve will on and off 3 times. Keep safety Lock located at USER MODE before test.
	6. Jet Valve 2	
	7. Jet Valve 3	
	8. Jet Valve 4	
	9. Jet Valve 5	

Ext Ignite	OFF / ON	Trigger through 9-60V ExtIgnite signal (such as fireworks ignitor signal) ON/OFF switch. Firing all 5 heads.
Ext Ignite Time	0.1-2.0 S	Firing time setup when activated through ExtIgnite signal
Language	English / Chinese	Language switch
Mode Select	OFF / ON	Turn ON/OFF tip over function
DMX channel mode	6CH Normal Mode / 6CH Pro Mode/ 6CH Safe Mode	DMX channel mode switch, detail info please check 5.DMX control
Default Parameter	OFF / ON	Reset default parameter settings
Invert	OFF / ON	When turned on, all angles will be mirrored.
Fuel Input	OFF / ON	When ON, operators can fuel machine through Fuel Input Quick Coupler
Priming Valve	AUTO / COMPEL ON	Turn on the Priming Valve
Current Voltage	12V	Mainboard power supply voltage display

## ▲ Operation Instructions

### 1. Direction explanation

Please read the safety distance printed on top panel of CIRCLE FLAMER carefully.

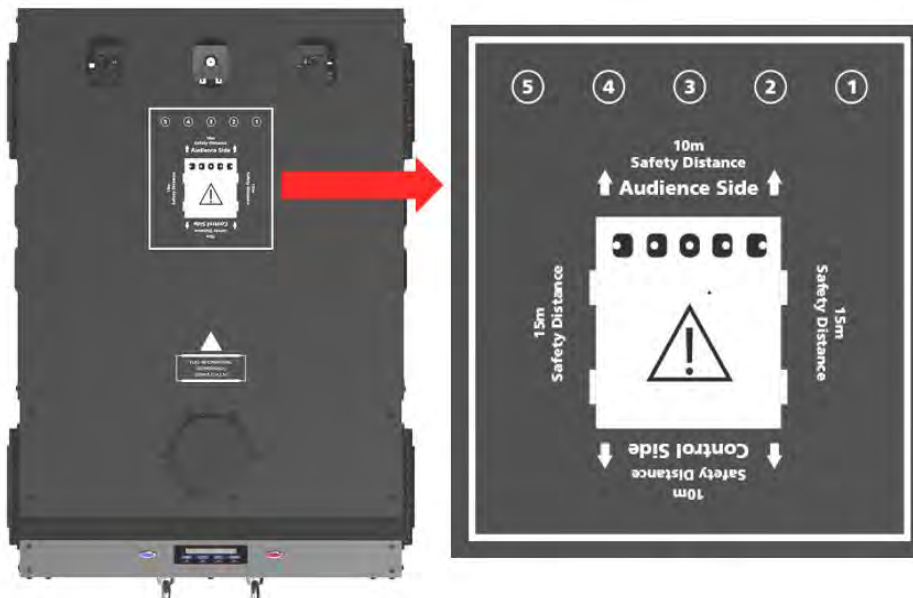

1.1-5 indicate the related head number of uFlamer Volcano. Right side one is head 1, head 3 is in the middle, left side is head 5.







2. Audience side and control side are indicated in the picture.





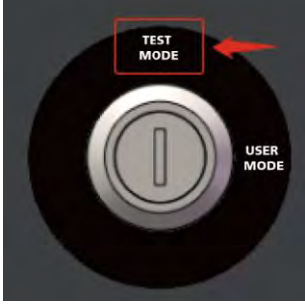

3. Safety distances for uFlamer Volcano are indicated in above picture. At least 15m in all projection directions, at least 10m to the audience side and control side.

### 2. Quick Operation Sheet

Immediately upon receiving the machine, carefully unpack the packing carton, check the machine received in good condition. Ensure safety operation of machine, please do following below operation procedures when operate uFlamer Volcano.

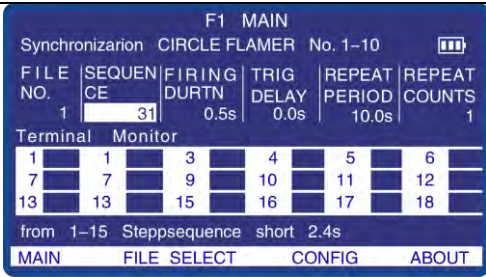

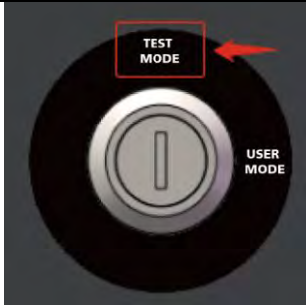
Operation step	Schematic diagram and explanation	Explanation
Installation	The device can only be placed horizontally, if placed on truss, please locked with extra safety ropes.	
Locate safety lock at TEST MODE		Before operate machine please locate safety lock at TEST MODE. <b>TEST MODE:</b> operator can test the device, but the fuel ejection function disabled, so there is no fuel eject and flames. <b>USER MODE:</b> the device can generate flames normally. Please strictly follow the safety distance requirement, remove all human, animal or flammable objects in the danger area.
Fueling		Please fueling with high quality fuel according to requirement of this manual
Power and DMX cable connection		Make sure power supply in consistent with the rated voltage of the equipment, and the socket must well grounded.
Switch ON the machine		Please confirm safety lock located at TEST MODE before switch on the POWER ON/OFF.
Set DMX address		Please refer to 5. DMX control.
Compression		<b>Host controller:</b> Press "pre-heat" button (light on) <b>DMX console:</b> switch DMX value of channel 6 to 50-200
Check device status in TEST MODE		Reconfirm safety lock located at TEST MODE before test. In this status, igniter will activated, but there is no flame.
Pressure Relief		<b>Host controller:</b> Press "pre-heat" key (light off) <b>DMX console:</b> switch DMX value of channel 6 to 0-49/201-255

<p>Press the safety lock to USER MODE</p>		<p>Before switch to USER MODE, Please strictly follow the safety distance requirements, remove all human, animal or flammable objects in the danger area.</p>
<p>Pressurise</p>		<p><b>Host controller:</b> Press "pre-heat" button (light on)  <b>DMX console:</b> switch DMX value of channel 6 to 50-200</p>
<p>Input firing sequence</p>		<p>For example, if want to firing sequence 31  <b>Host Controller:</b> input 31 @sequence  <b>DMX console:</b> channel 5 DMX value @ 80-81</p>
<p>Firing</p>		<p><b>Host controller:</b> Press "FIRING" key  <b>DMX console:</b> switch DMX value of channel 3 to 254-255</p>
<p>Pressure Relief</p>		<p>Relief pressure when show finished or CIRCLE FLAMER not use for a long period.  <b>Host controller:</b> Press "pre-heat" key (light off)  <b>DMX console:</b> switch DMX value of channel 6 to 0-49/201-255</p>
<p>Switch safety lock to TEST MODE</p>		<p>Guarantee safety use for next time</p>
<p>Power off</p>		<p>Power off, tear down power cable and DMX cable, pack up the device when it is cooled down.</p>

### 3. Angle Definitions

Below schematic shows 5 heads and the projection directions of uFlamer Volcano from Audience Side view.

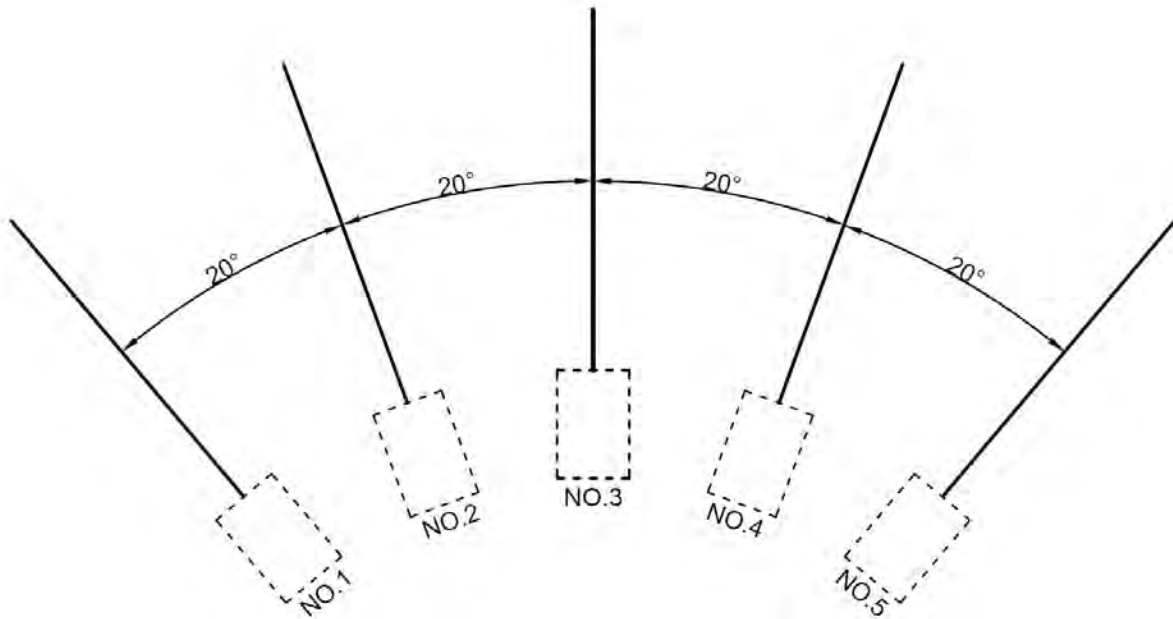

### 4. Firing sequence list

uFlamer Volcano with more than 97 preset firing sequences. Operator use related channel DMX value or sequence No. to access certain sequence. Sequence list as below:

#### Single Ignition Sequence List

Sequence No.	Ignition head No.	Description	Flame Activity	Firing Duration (for reference)	CH5 DMX Reference Value
1	1	Single ignition SHORT flame	Static	0.1s	3-5
2	2	Single ignition SHORT flame	Static	0.1s	6-7
3	3	Single ignition SHORT flame	Static	0.1s	8-10
4	4	Single ignition SHORT flame	Static	0.1s	11-12
5	5	Single ignition SHORT flame	Static	0.1s	13-15
6	1	Single ignition LONG flame	Static	0.28s	16-17
7	2	Single ignition LONG flame	Static	0.28s	18-20
8	3	Single ignition LONG flame	Static	0.28s	21-22
9	4	Single ignition LONG flame	Static	0.28s	23-25
10	5	Single ignition LONG flame	Static	0.28s	26-28

## Step Sequences List

Sequence No.	Ignition head No.	Description	Flame Activity	Firing Duration (for reference)	CH5 DMX Reference Value
11	Step 1-5	SHORT flame Step sequence	L -> R	0.54s	29-30
12	Step 5-1	SHORT flame Step sequence	R -> L	0.54s	31-33
13	Step 1>3>5>2>4	SHORT flame Step sequence	L>M>R>L>R	0.54s	34-35
14	Step 5>3>1>4>2	SHORT flame Step sequence	R>M>L>R>L	0.54s	36-38
15	Step 1>5>2>3>4	SHORT flame Step sequence	L>R>L>M>R	0.54s	39-40
16	Step 5>1>4>3>2	SHORT flame Step sequence	R>L>R>M>L	0.54s	41-43
17	Step 1>5>2>4>3	SHORT flame Step sequence	L>R>L>R>M	0.54s	44-45
18	Step 5>1>4>2>3	SHORT flame Step sequence	R>L>R>L>M	0.54s	46-48
19	Step 2>4>1>5>3	SHORT flame Step sequence	L>R>L>R>M	0.54s	49-50
20	Step 4>2>5>1>3	SHORT flame Step sequence	R>L>R>L>M	0.54s	51-53
21	Step 2>4>3>1>5	SHORT flame Step sequence	L>R>M>L>R	0.54s	54-56
22	Step 4>2>3>5>1	SHORT flame Step sequence	R>L>M>R>L	0.54s	57-58
23	Step 2>3>4>1>5	SHORT flame Step sequence	L>M>R>L>R	0.54s	59-61
24	Step 4>3>2>5>1	SHORT flame Step sequence	R>M>L>R>L	0.54s	62-63
25	Step 3>1>5>2>4	SHORT flame Step sequence	M>L>R>L>R	0.54s	64-66
26	Step 3>5>1>4>2	SHORT flame Step sequence	M>R>L>R>L	0.54s	67-68
27	Step 3>2>4>1>5	SHORT flame Step sequence	M>L>R>L>R	0.54s	69-71
28	Step 3>4>2>5>1	SHORT flame Step sequence	M>R>L>R>L	0.54s	72-73
29	Step 2>3>4	SHORT flame Step sequence	L>M>R	0.32s	74-76
30	Step 4>3>2	SHORT flame Step sequence	R>M>L	0.32s	77-79
31	Step 1>3>5	SHORT flame Step sequence	L>M>R	0.32s	80-81
32	Step 5>3>1	SHORT flame Step sequence	R>M>L	0.32s	82-84
33	Step 1>5	SHORT flame Step sequence	L->R	0.21s	85-86
34	Step 5>1	SHORT flame Step sequence	R->L	0.21s	87-89
35	Step 2>4	SHORT flame Step sequence	L->R	0.21s	90-91
36	Step 4>2	SHORT flame Step sequence	R->L	0.21s	92-94
37	Step 1-5	LONG flame Step sequence	L->R	1.45s	95-96

38	Step5-1	LONG flame Step sequence	R>L	1.45s	97-99
39	Step 1>3>5>2>4	LONG flame Step sequence	L>M>R>L>R	1.45s	100-101
40	Step 5>3>1>4>2	LONG flame Step sequence	R>M>L>R>L	1.45s	102-104
41	Step 1>5>2>3>4	LONG flame Step sequence	L>R>L>M>R	1.45s	105-107
42	Step 5>1>4>3>2	LONG flame Step sequence	R>L>R>M>L	1.45s	108-109
43	Step1>5>2>4>3	LONG flame Step sequence	L>R>L>R>M	1.45s	110-112
44	Step 5>1>4>2>3	LONG flame Step sequence	R>L>R>L>M	1.45s	113-114
45	Step 2>4>1>5>3	LONG flame Step sequence	L>R>L>R>M	1.45s	115-117
46	Step 4>2>5>1>3	LONG flame Step sequence	R>L>R>L>M	1.45s	118-119
47	Step 2>4>3>1>5	LONG flame Step sequence	L>R>M>L>R	1.45s	120-122
48	Step 4>2>3>5>1	LONG flame Step sequence	R>L>M>R>L	1.45s	123-124
49	Step 2>3>4>1>5	LONG flame Step sequence	L>M>R>L>R	1.45s	125-127
50	Step 4>3>2>5>1	LONG flame Step sequence	R>M>L>R>L	1.45s	128-130
51	Step 3>1>5>2>4	LONG flame Step sequence	M>L>R>L>R	1.45s	131-132
52	Step 3>5>1>4>2	LONG flame Step sequence	M>R>L>R>L	1.45s	133-135
53	Step 3>2>4>1>5	LONG flame Step sequence	M>L>R>L>R	1.45s	136-137
54	Step 3>4>2>5>1	LONG flame Step sequence	M>R>L>R>L	1.45s	138-140
55	Step 2>3>4	LONG flame Step sequence	L>M>R	0.86s	141-142
56	Step 4>3>2	LONG flame Step sequence	R>M>L	0.86s	143-145
57	Step 1>3>5	LONG flame Step sequence	L>M>R	0.86s	146-147
58	Step 5>3>1	LONG flame Step sequence	R>M>L	0.86s	148-150
59	Step 1>5	LONG flame Step sequence	L>R	0.57s	151-152
60	Step 5>1	LONG flame Step sequence	R>L	0.57s	153-155
61	Step 2>4	LONG flame Step sequence	L>R	0.57s	156-158
62	Step 4>2	LONG flame Step sequence	R>L	0.57s	159-160
63	Step 15>3>24	SHORT flame Step sequence	LR>M>LR	0.40s	161-163
64	Step 24>3>15	SHORT flame Step sequence	LR>M>LR	0.40s	164-165
65	Step 15>24>3	SHORT flame Step sequence	LR>LR>M	0.40s	166-168
66	Step 3>24>15	SHORT flame Step sequence	M>LR>LR	0.40s	169-170

67	Step 3>15>24	SHORT flame Step sequence	M>LR>LR	0.40s	171-173
68	Step 24>15>3	SHORT flame Step sequence	LR>LR>M	0.40s	174-175
69	Step 24>135	SHORT flame Step sequence	LR>LMR	0.25s	176-178
70	Step 135>24	SHORT flame Step sequence	LMR>LR	0.25s	179-181
71	Step 15>234	SHORT flame Step sequence	LR>LMR	0.25s	182-183
72	Step 234>15	SHORT flame Step sequence	LMR>LR	0.25s	184-186
73	Step 15>3>24	LONG flame Step sequence	LR>M>LR	0.86s	187-188
74	Step 24>3>15	LONG flame Step sequence	LR>M>LR	0.86s	189-191
75	Step 15>24>3	LONG flame Step sequence	LR>LR>M	0.86s	192-193
76	Step 3>24>15	LONG flame Step sequence	M>LR>LR	0.86s	194-196
77	Step 3>15>24	LONG flame Step sequence	M>LR>LR	0.86s	197-198
78	Step 24>15>3	LONG flame Step sequence	LR>LR>M	0.86s	199-201
79	Step 24>135	LONG flame Step sequence	LR>LMR	0.57s	202-203
80	Step 135>24	LONG flame Step sequence	LMR>LR	0.57s	204-206
81	Step 15>234	LONG flame Step sequence	LR>LMR	0.57s	207-209
82	Step 234>15	LONG flame Step sequence	LMR>LR	0.57s	210-211

#### Multi ignition firing sequence list

Sequence No.	Ignition head No.	Description	Flame Activity	Firing Duration (for reference)	CH5 DMX Reference Value
83	12345	Multi ignition SHORT flame	Static	0.1s	212-214
84	1245	Multi ignition SHORT flame	Static	0.1s	215-216
85	234	Multi ignition SHORT flame	Static	0.1s	217-219
86	135	Multi ignition SHORT flame	Static	0.1s	220-221
87	15	Multi ignition SHORT flame	Static	0.1s	222-224
88	24	Multi ignition SHORT flame	Static	0.1s	225-226
89	12345	Multi ignition LONG flame	Static	0.28s	227-229
90	1245	Multi ignition LONG flame	Static	0.28s	230-232
91	234	Multi ignition LONG flame	Static	0.28s	233-234
92	135	Multi ignition LONG flame	Static	0.28s	235-237

93	15	Multi ignition LONG flame	Static	0.28s	238-239
94	24	Multi ignition LONG flame	Static	0.28s	240-242
95	3	Multi ignition LONG flame	Static	User defined	243-244
96	234	simultaneously	Static	User defined	245-247
>97	12345	simultaneously	Static	User defined	248-255

## 5. DMX control

### 1. Normal Channel Mode

Channel	Function
CH1	Manual mode head selection 0: all five heads                      1-51: head NO.1 52-102: head NO.2                      103-153: head NO.3 154-204: head NO. 4                      205-255: head NO.5
CH2	/
CH3	Ignition ON/OFF 0~253: ignition OFF; 254~255: ignition ON
CH4	Firing duration setup 0 and 255 is permanent firing (8s is limit duration firing time, 5 heads simultaneously firing limit time is 2s); 1~254 correspond to 10~2540ms duration time (Manual firing duration = DMX Value * 10ms)
CH5	Program sequence setup 0-2: no preset sequence; set according to CH1 and CH4; 3~255: preset sequence. DMX Value = 2+ Sequence No. * 2.55 (round off). CH1 and CH4 invalid.
CH6	Mode setup 0~49: Pressure Relief Mode (Emergency Stop) 50~200: Firing Mode 201~255: Pressure Relief Mode (Emergency Stop)

### 2. Professional Channel Mode

Channel	Function
CH1	Head NO.1: 0~253: Firing OFF; 254~255: Firing ON
CH2	Head NO.2: 0~253: Firing OFF; 254~255: Firing ON
CH3	Head NO.3: 0~253: Firing OFF; 254~255: Firing ON
CH4	Head NO.4: 0~253: Firing OFF; 254~255: Firing ON
CH5	Head NO.5: 0~253: Firing OFF; 254~255: Firing ON
CH6	Mode setup 0~49: Pressure Relief Mode (Emergency Stop) 50~200: Firing Mode 201~255: Pressure Relief Mode (Emergency Stop)

### 3. Safety Channel Mode

Channel	Function
CH1	Manual mode head selection 0: all five heads 52-102: head NO.2 154-204: head NO. 4 1-51: head NO.1 103-153: head NO.3 205-255: head NO.5
CH2	/
CH3	Ignition ON/OFF 0~253: ignition OFF; 254~255: ignition ON
CH4	Firing duration setup 0 and 255 is permanent firing (8s is limit duration firing time, 5 heads simultaneously firing limit time is 2s); 1~254 correspond to 10~2540ms duration time (Manual firing duration = DMX Value * 10ms)
CH5	Program sequence setup 0-2: no preset sequence; set according to CH1 and CH4. 3~255: preset sequence. DMX Value = 2+ Sequence No. * 2.55 (round off). CH1 and CH4 invalid.
CH6	Mode setup 0~49: Pressure Relief Mode (Emergency Stop) 50~200: Firing Mode 201~255: Pressure Relief Mode (Emergency Stop)

## ▲ SHOWVEN host controller ZK6200/ZK6300

### 1. Hardware description:

\ MODEL: ZK6200/ZK6300

\ DIMENSION: 390×300×110mm

\ WEIGHT: 3.5kg

\ VOLTAGE: 100-240V, 50/60Hz

\ POWER: 15W

\ MAX CASCADE OF DEVICE: 18units (ZK6200)/ 54units (ZK6300)

\ SUPPORT MACHINES: SPARKULAR series, CIRCLE FLAMER series, SONICBOOM series

### 2. SHOWVEN host controller introduction:

1. Standard DMX512 signal output
2. Support 18units (ZK6200) or 54units (ZK6300) of uFlamer Volcano
3. 5 standard dynamic modes: Synchronization, Center to Ends, Ends to Center, Left to Right, Right to Left. And an user definable Special Effect mode, support 8 files, each file support 36000 lines maximum (effects lasts for 30min)
4. Multi trigger sources: manual, music or midi input
5. RDMX monitoring function: system can send back uFlamer Volcano working status info such as pressure, warming etc. and display on the screen
6. Emergency stop function



### 3. Operational Panel

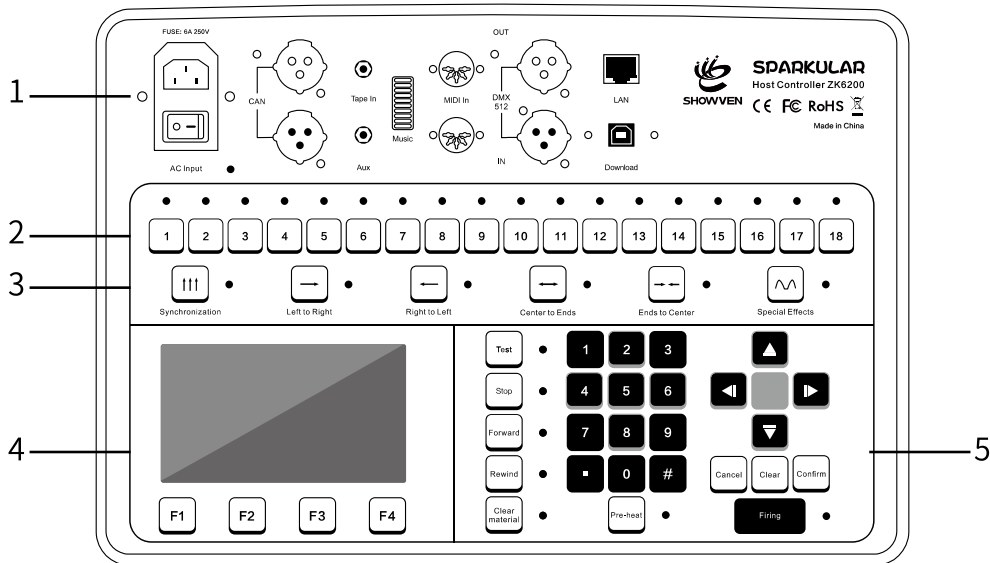

1. Cable connection area
2. Manual firing operation region
3. Mode selection area
4. LCD display area
5. Edit/Control area

### 2. Maintenance

1. To maintain the system in good performance and running status, it is recommended to running the device at least once per month.

2. Maintenance of the nozzle: Nozzle need to be cleaned up , and it is recommended that once every six months (depending on the environment and frequency of use). In the process of using the equipment, if the flame shape is seriously deformed or the fuel injection line is significantly deformed or coarsened, the nozzle should be removed immediately for cleaning.

3. Maintenance of the O-ring: If it is found that the O-ring of the nozzle is damaged or ageing when cleaning the nozzle, the O-ring should be replaced in time (material and size of O-ring: fluororubber O-ring, the outermost diameter is 14 mm, and the line diameter is 2 mm).

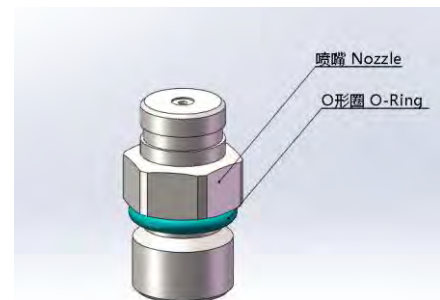

### ▲ Accessories list

No.	Part No.	Description	QTY
1	RMWAS025	Fluororubber O-ring	5
2	RMBOT036	Safety loop	2

# Warranty Instructions

- ▲ Sincere thanks for your choosing uFlamer Volcano, you will receive quality service from us.
- ▲ The product warranty period is one year. If there are any quality problems within 7 days after shipping out from our factory, we can exchange a brand new same model machine for you.
- ▲ We will offer free of charge maintenance service for machines which with hardware malfunction (except for the instrument damage caused by human factors) in warranty period. Please don't repair machine without factory permission.

★ Below situations NOT included in warranty service:

1. Damage caused by improper transportation, usage, management, and maintenance, or damage caused by human factors;
2. Disassemble, modify or repair products without Showven's permission;
3. Damage caused by external reasons (lightning strike, power supply etc)
4. Damage caused by improper installation or use;

For product damage not included in warranty range, we can provide paid service.

★ Invoice and warranty card are necessary when applying for maintenance service from SHOWVEN.

## Warranty Card

<b>Product Name:</b>		<b>Serial No.</b>	
<b>Purchase Date:</b>			
<b>Tel:</b>			
<b>Address:</b>			
<b>Info. feedback about the problem:</b>			
<b>Actual problem:</b>			
<b>Maintenance detail:</b>			
<b>Service Engineer:</b>		<b>Service Date:</b>	



# SHOWVEN®

**PREMIUM FACTORY SAS - DISTRIBUTEUR OFFICIEL**  
**1 Route Neuve, 71710 MONTCENIS - FRANCE Office**  
**+33 805 69 13 27 | +33 608 630 452**  
**[info@premiumfactory.eu](mailto:info@premiumfactory.eu) | [www.premiumfactory.eu](http://www.premiumfactory.eu)**