

USER MANUAL

uPumper P20

V1.0

2022.03

SHOWVEN®



SHOWVEN Technologies Co., Ltd

Thanks for choosing SHOWVEN uPumper P20, we wish it will bring you lots of exciting moments. Please read the following manual carefully before operating this product.

▲ Warning

- ✘ Unauthorized repair are prohibited, it may cause serious incident.
- ✘ Make sure power supply in consistent with the rated voltage of the equipment, and the socket must well grounded. Unplug and turn off the machine when not use.
- ✘ The device use 3-phase 5-wire system for power supply (2.5 square wire diameter). When any phase or zero line is missing, system will protect automatically and the device can't start up.
- ✘ Always have a CO2 fire extinguisher and an extinguishing blanket in case of needed.
- ✘ If there be any doubt as to the safety operation of the device in any circumstances, the device should be taken out of service immediately by press the E-stop key on machine. Be sure the device is in good operating condition before use. If fail to fire correctly, immediately shut down and check it accordingly. Any questions please always contact SHOWVEN (info@showven.cn) for help.
- ✘ Be sure to use high quality flame fluid, otherwise, it is easily leads to failure or danger. Be careful when refill the flame fluid tank. Please keep flame fluid away from heat source, sparks, fire or other possibility of ignition. Do not smoke!
- ✘ The operator responsible for the control of uPumper P20 and flame head must always have a clear view of the device, so that he/she can stop the show immediately when there is danger. The main AC power switch should near operator. So that operator can turn off the power of all devices in case of abnormal.
- ✘ The device shall not be altered and applied to other use purpose.

▲ Disclaimers

SHOWVEN technologies Co., Ltd excludes liability for unsafe situations, accidents and damages resulting from:

1. Ignoring warnings or regulations as shown on uPumper P20 or this manual.
2. Use for other applications or circumstances other than those indicated herein.
3. Changes to the uPumper P20, including use of non-original spare parts, lack of maintenance etc.
4. Dismantling uPumper P20 without authorization from SHOWVEN.
5. Use this machine by unqualified or untrained personnel.
6. Improper use of machine.

▲ Functional Characteristics

- ✘ Remote fuel and pressure supply for flame head
- ✘ Built in pump, no need extra Nitrogen tank.
- ✘ Electronic digital fuel level display
- ✘ Configured with pressure monitoring
- ✘ Equipped with E-stop, overflow valve etc. multi safety design
- ✘ Equipped with intelligent electronic control alarm system

▲ Technical Specifications

- ✘ **Model:** uPumper P20
- ✘ **Weight:** 285KG
- ✘ **Casing Material:** 304 stainless steel
- ✘ **Work Power:** 6KW

- \ Input: AC 380V
- \ Tank Capacity: 250L
- \ Pressure Range: 1-2.5MPa adjustable (customizable up to 4.5MPa)
- \ Pump Output: 110L/min
- \ Work TEMP.: -20 °C-50 °C

▲ Structure

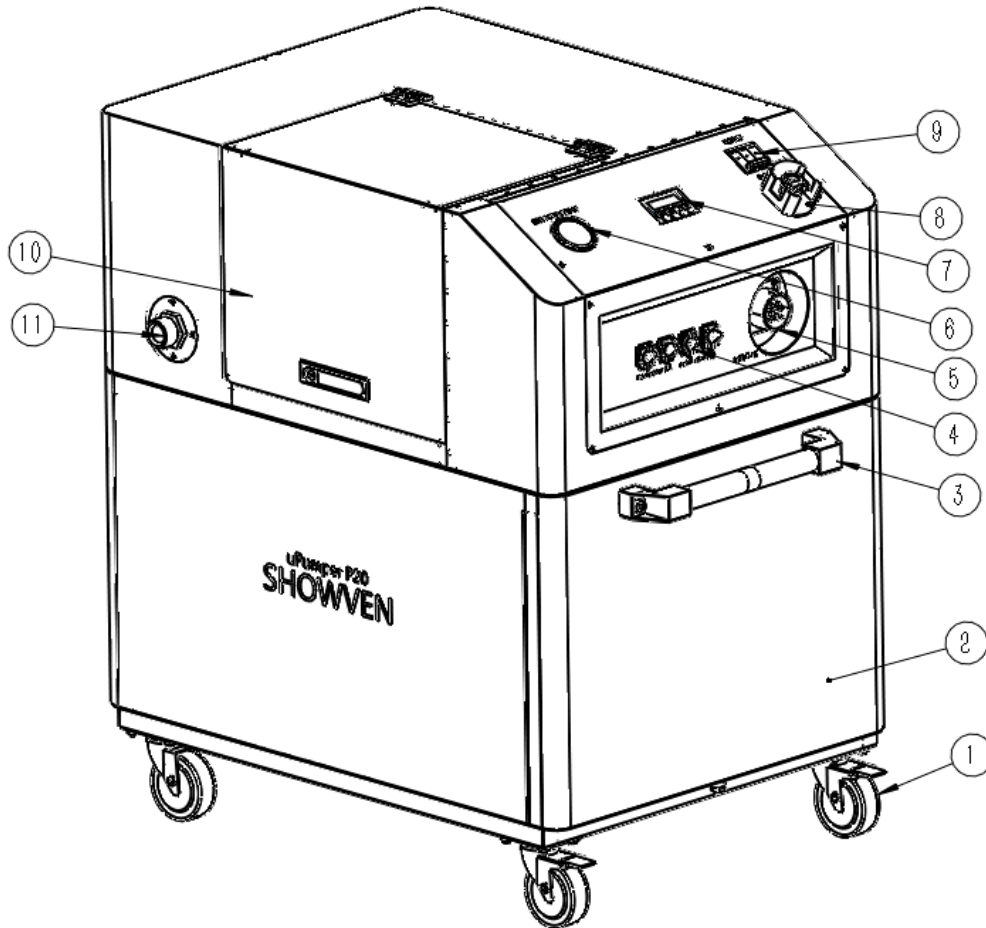

- | | | | |
|-----------------------|---------------|-----------------------------------|--|
| 1. Castor | 2. Fuel Tank | 3. Handle | 4. 3-pin and 5-pin XLR |
| 5. Power Input AC380V | 6. Manometer | 7. LCD screen and Operation Panel | |
| 8. Emergency STOP | 9. 3P Breaker | 10. Cover | 11. G 1¼ Quick Coupler for Fuel Outlet |

▲ Operation Panel

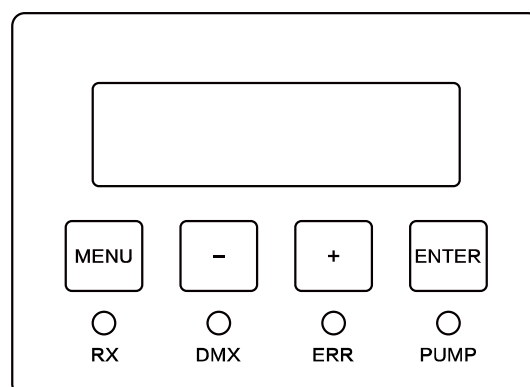

a) LED Display Area

RX: Radio receiving (reserved);

DMX : DMX signal. Flash means DMX signal available, otherwise no DMX signal;

ERR: Light on when there is an error;

PUMP: Light on when pump is running.

b) Button Functions

MENU: Switch interface to setup parameter;

+: Parameter Up;

-: Parameter Down;

ENTER: Confirm and save parameters (screen will flash when parameters saved)

Note: screen display will switch to main interface if don't press button in 15s.

c) Welcome Interface

First Line: Product model and software version

Second Line: Equipment series number

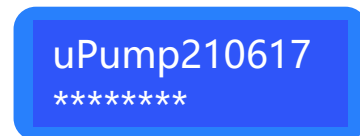

d) Main Interface

First Line

DMX: DMX address 1 (value from 1-512)

M: AUTO means auto control; DMX-C means console control

Second Line:

P: Pressure Value 100 (100=10bar)

L: Liquid level 50%



e) Alert Message

Alert Message	Explanation
E0.1 Fuel Low	When the fuel level in fuel tank less than setting low fuel level for continuous 5s, machine will stop working and report E1. When refueling and fuel level exceed low fuel level, alert message eliminate automatically.
E0.2 P Relief ON	Relief solenoid valve ON. Close relief solenoid valve, error eliminate.
E0.3 KEY STOP	Press the Emergency STOP key. Reset the Emergency stop key, error eliminate.
E0.4 Factory Mode	Factory Mode Switch to Normal Mode, error eliminate.
E2 PressureFail	When pressurize, if machine running time exceed Pump Pro Time while the pressure value still lower than Pump Pro Pre (Pump protection pressure), report E2 PressureFail. Please restart the machine.

f) Interface Setup

Press "MENU" to switch through setup menu.

Menu	Range	Default setting	Explanation
Pressure Relief	OFF/ON	OFF	ON: relief pressure (depressurize) OFF: stop relief pressure
Set DMX Address	1~512	1	DMX address setup
Control Mode	AUTO / DMX control	DMX control	AUTO: pump running automatically when turn on the machine. DMX control: control the running of pump through DMX console
Language	Chinese/English	English	Language switch
DefaultParamete	ON/OFF	OFF	Reset default parameter settings
Mode Select	Normal Mode/ Factory Mode	Normal mode	Please set normal mode for regular use of machine.

g) Advanced Interface

To ensure the safety advanced interface was valid only when Pressure Relief stays at ON status. Press and hold "MENU" for 3s enter advanced interface, press "MENU" to switch interface, press "MENU" 3s can back to main interface.

Menu	Contents	Explanation
Drive Test	Pump	Pump running 2s. if pump pressure exceed 95, pump not running.
	Relief Valve	Relief valve will be on and off 3 times
	Switch Valve	Switch valve will be on and off 3 times

h) Factory menu

Press and hold "ENTER" for 3s enter advanced interface, press "MENU" to switch interface, press "ENTER" 3s can back to main interface.

Menu	Range	Default setting	Explanation
Set Pressure	60-350	120	If current pressure > Set Pressure, switch valve off (close)
Set LowPressure	0-150	90	If current pressure < set LowPressure, switch valve ON
Fuel Low	0-50%	20	If fuel level < Fuel Low for continuous 5s, pump stop running, machine report E0.1 Fuel Low.
Pump Pro Pre	0-100	50	When pressurize, if machine running time exceed Pump Pro Time while the pressure value still lower than Pump Pro Pre, report E2 PressureFail.
Pump Pro Time	0-180s	30s	
P Relief Count	0-300s	30s	Pressure relief count down time
Run LOCK	ON/OFF	OFF	When Run Lock ON, need code to start machine

i) Control

DMX Control

uPumper P20 just occupy a single channel.



Channel Value	Function
0~49	Depressurize, pump OFF
50~200	Pressurize, pump ON
201~255	Depressurize, pump OFF

Auto Control

Press MENU enter setting interface, find Control Mode, select AUTO control. Machine start count down then Pump will start work after finish count down.

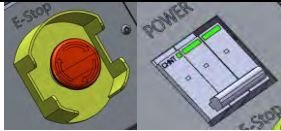
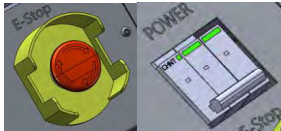

▲ Quick Operation Instructions

a) DMX Control Mode (default)

Step	Content	Schematic diagram	Remark
1	Plug in		The device use 3-phase 5-wire system for power supply (2.5 square wire diameter). When any phase or zero line is missing, system will protect automatically and the device can't start up.
2	Connect XLR cable		After turn on machine, the DMX indication light will flash if received DMX signal.
3	Filling the fuel tank		ISOPAR
4	Reset the E-stop key, Power ON the device		Wait a delay of 15s for startup, device performs pipeline pressure relief automatically (default pressure relief time is 30s), wait until the device enter main interface on LCD screen.
6	Set DMX address	<div style="border: 1px solid black; padding: 5px; text-align: center;">Set DMX Address 1</div>	
7	Pressurize or pressure relief through DMX console		DMX channels value 0~49: Depressurize, pump OFF (E-stop) 50~200: Pressurize, pump ON 201~255: Depressurize, pump OFF (E-stop)
8	Press E-Stop, then Power OFF		After the show, please first press E-Stop to relief the pressure, then power off the machine.
9	Emergency Stop		Under emergency situation please press E-stop. After press E-Stop: 1. Power supply of drive motor was disconnected 2. Relief valve was turned on 3. Pipeline pressure was eliminated 4. System stops working.

b) Auto Pressurization Mode

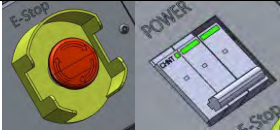
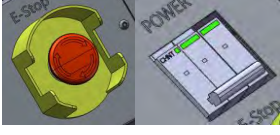
Step	Content	Schematic diagram	Remark
1	Plug in		The device use 3-phase 5-wire system for power supply (2.5 square wire diameter). When any phase or zero line is missing, system will protect automatically and the device can't start up.
2	Filling the fuel tank		ISOPAR

3	Reset the E-stop key, Power ON the device		Wait a delay of 15s for startup, device performs pipeline pressure relief automatically (default pressure relief time is 30s), wait until the device enter main interface on LCD screen.
4	Auto pressurize		Pump will working automatically to pressurize the pipeline system (default value of pressure is between 90-120. 120=12bar)
5	Press E-Stop, then Power OFF		After the show, please first press E-Stop to relief the pressure, then power off the machine.
6	Emergency Stop		Under emergency situation please press E-stop. After press E-Stop: 1. Power supply of drive motor was disconnected 2. Relief valve was turned on 3. Pipeline pressure was eliminated 4. System stops working.

▲ Maintenance

1. To maintain the system in good performance and running status, it is recommended to running the device at least once per month.
2. Ensure there are enough fuel inside fuel tank before turn on machine.

▲ Warranty Instructions

- √ Sincere thanks for your choosing our products, you will receive quality service from us
- √ The product warranty period is one year. If there are any quality problems within 7 days after shipping out from our factory, we can exchange a brand new same model machine for you
- √ We will offer free of charge maintenance service for machines which with hardware malfunction (except for the instrument damage caused by human factors) in warranty period. Please don't repair machine without factory permission

Below situations NOT included in warranty service:

- √ Damage caused by improper transportation, usage, management, and maintenance, or damage caused by human factors;
- √ Disassemble, modify or repair products without permission;
- √ Damage caused by external reasons (lightning strike, power supply etc.)
- √ Damage caused by improper installation or use;

For product damage not included in warranty range, we can provide paid service.

Invoice is necessary when applying for maintenance service from SHOWVEN

SHOWVEN[®]

PREMIUM FACTORY SAS - DISTRIBUTEUR OFFICIEL
1 Route Neuve, 71710 MONTCENIS - FRANCE Office
+33 805 69 13 27 | +33 608 630 452
info@premiumfactory.eu | www.premiumfactory.eu